

2024

www.swstahl.de

TOOLNEWS

FOR PROFESSIONALS

T I M I N G T O O L S



DESIGNED
IN GERMANY

9 | Torque
reproducer

10 | Engine
timing
tool set

16 | Counterholder
camshaft and
crankshaft

ENGINE ADJUSTMENT TOOLS FOR PROFESSIONALS

SW STAHL
PROFESSIONAL TOOLS

OUR NEW ENGINE ADJUSTMENT TOOLS

For even more professional performance in your work, we have completely revised some of our engine adjustment tools.

Engine setting tools are the centrepiece of every workshop and the secret to perfect performance in the automotive industry. They are not only important, but essential to ensure the precision and efficiency of engines.

With our brand new SW STAHL design case for engine setting tools, the tool is not only stored neatly and safely, but is also the eye-catcher in your workshop.

Our engine setting tools focus on durability and reliability. Made from robust steel, they can withstand the stresses and strains of everyday workshop use and will last you a long time.

We have developed a comprehensive range of tools to cover a variety of vehicle models from leading brands such as Audi, Seat, Skoda, VW to Opel, Fiat, Iveco and many others.

Whether it's the counterholder for camshafts and crankshafts, crankshafts or the puller set for camshaft sprockets - we have the right engine setting tool for your workshop. Our new generation of engine setting tools will take your work to a whole new level and give you the confidence that you are well equipped for any challenge in the automotive industry.



CHUCK KEY SET FOR V-RIBBED BELTS, DOUBLE HEXAGONAL, 5-PIECE

for pre-tensioning the tensioning device for auxiliary belts e.g. for Audi, VW, Ford, Seat, Skoda etc.

- ▶ With angled tips (ca. 45°), ideal where space is tight in the engine compartment
- ▶ Due to the angled shape, no additional extension measures are necessary
- ▶ 19 mm wrench size especially needed for Audi A4, VW Passat from '97 TDI (pump/blast pipe)
- ▶ Non-slip handle for safe work
- ▶ In a practical case
- ▶ Length 460 mm each



DESCRIPTION	ARTICLE	PRICE EUR*
Chuck key set for V-ribbed belts, double hexagonal, 5-piece	10557L	99,90
Torque wrench for V-ribbed belt	10557L-13	28,50
Torque wrench for V-ribbed belt	10557L-15	28,50
Torque wrench for V-ribbed belt	10557L-16	28,50
Torque wrench for V-ribbed belt	10557L-17	28,50
Torque wrench for V-ribbed belt	10557L-19	28,50

CLAMPING KEY FOR V-RIBBED BELTS

for VAG vehicles WITHOUT tensioning roller.

Here, the belt is tensioned via the spring-loaded generator. With the aid of this key, the generator can be turned accordingly to slacken the belt, e.g. during replacement work.

The 12,5 mm (1/2") drive is attached in a star shape and thus allows the tool to be inserted in different ways depending on the space available.

The pins are knurled, reducing the risk of the key slipping out of the generator.



Suitable for the following vehicles:

- ▶ Audi 80 (1991-1995), A2 (2000-2005), A4 (1994-2001), A6 (1994-1997), A6 (1997-2005), Cabriolet (1991-2000)
- ▶ Seat Alhambra (1996-2010), Arosa (1997-2004), Cordoba (1993-2002), Cordoba (2002-2009), Ibiza (1993-2002), Ibiza (2002-2009), Ibiza (2008-2017), Inca (1995-2003), Toledo (1991-1999)
- ▶ Skoda Fabia (1999-2008), Fabia (2006-2014), Felicia (1994-1998), Felicia (1998-2001), Octavia (1996-2010), Roomster (2006-2015)
- ▶ VW Caddy (1995-2004), Caddy (2004-2015), Corrado (1987-1995), Fox (2003-2014), Golf (1991-1999), Golf (1997-2007), Lupo (1998-2005), Passat (1988-1997), Passat (1996-2005), Polo (1994-2001), Polo (2001-2012), Sharan (1995-2010), Vento (1991-1998), Transporter T4 (1990-2004)

Motorcodes:

1F, 1X, 1Y, 1Z, 2E, AAM, AAZ, ABD, ABL, ABS, ABU, ADX, ADY, ADZ, AEA, AEE, AEK, AER, AEV, AEX, AEY, AFN, AFT, AGG, AHB, AHH, AHU, AKK, AKP, AKR, AKS, AKV, AKW, ALD, ALE, ALL, ALM, AMF, ANN, ANP, ANV, ANW, ANX, APQ, ATU, AUC, AUD, AVG, AWF, AWG, BAH, BAY, BKR, BMS, BNM, BNV, BWB
Used as OE no VAG 3297 and Seat U-40050.

DESCRIPTION	ARTICLE	PRICE EUR*
Clamping key for V-ribbed belts	10582L	19,90

V-RIBBED BELT WRENCH, VAG

for tensioning V-ribbed belts on 1.4 TSI / TFSI, 1.9 TDi, 3.0 TDi and 4.0 TDi engines.

The tool has a spanner size of 16 mm.

Suitable for the following vehicles:

- ▶ Audi: A1 (2010-2018), A4 (2015-), A5 (2016-), A6 (2010-2018), A7 (2010-2018), Q5 (2016-), Q7 (2015-)
- ▶ Seat: Alhambra (2010-), Ibiza (2008-2017)
- ▶ VW: CC (2011-2016), Eos (2006-2015), Golf V (2003-2009), Golf VI (2008-2013), Passat (2005-2011), Passat (2010-2014), Passat CC (2008-2012), Polo (2009-2017), Scirocco (2008-2017), Sharan (2010-), Tiguan (2007-2016), Touran (2003-2010), Transporter T5 (2003-2015)

Engine codes: AXB, AXC, BLG, BMY, BRR, BRS, BWK, CAVA, CAVB, CAVC, CAVD, CAVE, CAVF, CAVG, CAXA, CDGA, CKMA, CNUA, CNUB, CNVA, CNWA, CNWB, CRTD, CRTE, CRTF, CRTS, CSWB, CTHA, CTHB, CTHC, CTHD, CTHE, CTHF, CTHG, CTJA, CTJB, CTJC, CTKA, CUEA, CVMD, CVZA, CZAA, CZAC, CZVA, CZVB, CZVC, CZVD, CZVE, CZVF, CZZA, CZZB, DCDB, DCPC

Used equivalent to OE number T10447.



DESCRIPTION	ARTICLE	PRICE EUR*
V-ribbed belt wrench, VAG	26193L	10,90

V-RIBBED BELT TOOL SET, 10-PIECE

for the straightforward removal and fitting of new elastic V-ribbed belts (e.g. air-conditioning compressor).

Also suitable for use with double-belt drives.

Suitable for the following models:

- ▶ Audi A3
- ▶ BMW 118, 120, 318, 320, 325, 330, 335, 520, 525, 530, 535, 635, 730, X3, X5
- ▶ Chrysler Grand Voyager, Voyager
- ▶ Citroën C2, C3, C4, Jumper, Relay
- ▶ Fiat Albea, Doblo, Ducato, Fiorino, Fiorino Qubo, Linea, Marea, Multipla, Palio, Siena, Stilo, Strada Pick Up
- ▶ Ford C-Max, Focus, Focus C-Max, Fusion, Mondeo, Tourneo, Transit
- ▶ Iveco Daily
- ▶ Lancia Lybra
- ▶ Mazda 2, 3, 5, Axela
- ▶ Mercedes-Benz Sprinter, Viano, Vito
- ▶ Peugeot 206, 207, 307, Boxer
- ▶ Seat Altea, Ibiza
- ▶ Skoda Octavia, Yeti
- ▶ Volvo C30, S40, V50
- ▶ VW EOS, Golf, Passat, Polo, Scirocco



DESCRIPTION	ARTICLE	PRICE EUR*
V-ribbed belt tool set, 10-piece	10587L	199,90
V-ribbed belt tool	10587L-9	22,50

V-RIBBED BELT TOOL SET, 4-PIECE

for the straightforward removal and fitting of new elastic V-ribbed belts even on double-belt drives.

Since there is no clamping unit, it is not possible to relieve belt tension. This makes the tool almost indispensable for professional removal and fitting work.



DESCRIPTION	ARTICLE	PRICE EUR*
V-ribbed belt tool set, 4-piece	10585L	99,90
Ribbed belt removal tool	10585L-A	69,90

BELT PULLEY REMOVER, POLY-V BELT, 40 - 168 MM

e.g. for generators, air-conditioning systems, water pumps.

- ▶ Tension range 40 - 168 mm
- ▶ Including 10 mm Allen key



DESCRIPTION	ARTICLE	PRICE EUR*
Belt pulley remover, Poly-V belt, 40 - 168 mm	10579L	26,90

BELT PULLEY ROTATING KEY

for turning over the engine

- ▶ the adjustable roller can be adjusted to each belt pulley size
- ▶ e.g. for Audi, BMW, Ford, Mercedes, Opel, Peugeot, Renault, Rover, Volvo, VW and diverse. Japanese manufacturers



DESCRIPTION	ARTICLE	PRICE EUR*
Belt pulley rotating key	10574L	14,90

BELT PULLEY KEY, UNIVERSAL

for fixing all belt pulleys, extra long lever and stable design to prevent damage to the components.

- ▶ Diameter approx. 170 mm
- ▶ For V-rib belts and flat belts



DESCRIPTION	ARTICLE	PRICE EUR*
Belt pulley key, universal	10573L	39,90

ARRESTER KEY FOR CRANKSHAFT, VAG

for VW 1.4 - 1.6 and 2.0 l engines.

- ▶ For arresting the crankshaft belt pulley on 4-valve engines with pin diameter 11.5 mm
- ▶ For arresting the crankshaft toothed belt wheel on 2-valve engines
- ▶ M8 bolt

Suitable for:

- ▶ VW Bora, Caddy, Golf, Lupo, New Beetle, Polo, Sharan, Touran, Transporter
- ▶ Audi A2, A3, A4, A5, TT
- ▶ Skoda Fabia, Octavia, Superb

Engine codes: ADX, AEA, AEE, AEH, AEX, AFH, AFK, AGP, AGR, AHW, AJM, AKL, ALN, AMF, ANA, ANY, APE, APE, APF, ARM, ATJ, AUA, AWH, CGGA, CGPB

Used equivalent to the following OE numbers:

- ▶ T30004
- ▶ 3415



DESCRIPTION	ARTICLE	PRICE EUR*
Arrester key for crankshaft, VAG	10586L	64,90

ARRESTER KEY

for crankshaft belt pulleys, for loosening and tightening the central screw for VW 1.6 l

- ▶ suitable for VW Bora, Golf, Lupo, New Beetle, Polo,
- ▶ Seat Ibiza, Cordoba
- ▶ for engine codes: ARC, ATN, AUS, AVY, AZD, BCB



DESCRIPTION	ARTICLE	PRICE EUR*
Arrester key	10584L	39,90

CRANKSHAFT ARRESTER, BMW/MINI/PEUGEOT

for loosening and tightening the crankshaft central screw.

Suitable for:

- ▶ BMW / Mini: N12, N14, N18, N40, N42, N43, N45, N46, N51, N52, N53, N63
- ▶ Peugeot: EP3, EP6, EP6DT, EP6DTS

Used equivalent to the following OE-number:

- ▶ BMW OE-No. 119280



DESCRIPTION	ARTICLE	PRICE EUR*
Crankshaft arrester, BMW/Mini/Peugeot	10589L	57,90

CRANKSHAFT COUNTERHOLDER FOR OPEL 1.0 / 1.2 / 1.4 L ECOFLEX

suitable for Opel Adam, Astra J, Cascada, Corsa D, Insignia, Meriva B, Mokka, Zafira C with 1.0 / 1.2 / 1.4 l ecoFlex engines.

For holding the crankshaft pulley and for releasing the central fixing screw. With the handle included, the counterholder can be extended by 65 cm, thus offering the possibility of releasing fixed screwed connections. An additional 1/2 " drive on the anvil alternatively allows use with a sliding handle.

Engine codes: A10XEP, A12XEL (LWD), A12XER (LDC), A14NEL (LUH), A14NET (LUJ), A14XEL (LDD), A14XER (LDD)

Used equivalent to OE numbers:

- ▶ Counterholder basic body (equivalent to OE EN-49979)
- ▶ Extension for counterholder (equivalent to OE EN-956-1)
- ▶ Adapter, 2-piece (equivalent to OE EN49979-100)



DESCRIPTION	ARTICLE	PRICE EUR*
Crankshaft counterholder for Opel 1,0 / 1,2 / 1,4 l ecoFlex	10566L	179,90

FLYWHEEL HOLDER, BMW/MINI

for blocking the flywheel when releasing and tightening the central screws on the vibration absorber (crankshaft belt pulley) in diesel and petrol engines with the following engine codes:

- ▶ M47T2 / M47TU / M57T2 / M57TU / M67 / N43 / N45 / N45T / N46 / N46T / N47 / N47S / N51 / N52 / N53 / N54 / W17

For the following work, e.g. when:

- ▶ Exchanging the vibration absorber
- ▶ Replacing the crank shaft radial seal ring (on the front)

Suitable for:

- ▶ 116i, 118i, 120i, 128i, 130i, 135i, 135is, 118d, 120d, 123d (E81, E82, E87, E88) / 316i, 318i, 318ti, 320i, 320Si, 323i, 325i, 325xi, 328i, 328xi, 330i, 330xi, 335i, 335xi, 318d, 320d, 320td, 325d, 330d, 330xd, 335d (E46, E90, E91, E92, E93) / 520i, 523i, 525i, 525xi, 530i, 530xi, 535i, 535xi, 520d, 525d, 525xd, 530d, 530xd, 535d, (E60, E61) / 630i, 635d (E63, E64) / 730i, 730d, 740d, (E38, E65, E66) / X3-2.0i, X3-2.0d, X3-3.0d, X5-3.0D, X6-3.5D, X6-3.0d, X6-3.5d(E53, E70, E83) / Z4-2.0i, Z4-2.5i, Z4-3.0i (E85, E86) / Mini One, (R50)

Used equivalent to the following OE numbers:

- ▶ Counter support (complete) 11 8 180
- ▶ Connecting holder 11 8 182
- ▶ Base plate 11 8 183
- ▶ Adaptor (for E65/M67) 11 8 184
- ▶ Adaptor with an adjusting sleeve (for E46/M47TU) 11 8 185



DESCRIPTION	ARTICLE	PRICE EUR*
Flywheel holder, BMW/Mini	10588L	99,90

SPANNER FOR TAMPERPROOF HARDWARE, ADJUSTABLE

for all double-hole nuts from 11 mm gap, with riveted pins. Pin diameter 4,1 mm, e.g.

- ▶ For fixing the screw-nut of the angle grinder
- ▶ Also applicable for fitting and removing the visco fan clutch VW



DESCRIPTION	ARTICLE	PRICE EUR*
Spanner for tamperproof hardware, adjustable	S1463	9,90

SPANNER FOR TAMPERPROOF HARDWARE SET WITH INTERCHANGEABLE PINS, 16-PIECE

With replaceable spigot and locking by knurled nut:

- ▶ Spigot diameter 2.5 - 3 - 4 - 5 - 6 - 7 - 8 - 9 mm
- ▶ Span 102 mm

Ideal as a counter-holder for the following applications:

- ▶ For repairs to transmissions and differentials, e.g. Daimler, Ford, Volvo etc.
- ▶ For viscous fan installation and removal in Audi A4, A6, A8, VW Passat
- ▶ Together with counter-holder 00120L also suitable for Ford, Opel, Vauxhall and GM
- ▶ For removing and mounting vibration dampers in pulley repairs



DESCRIPTION	ARTICLE	PRICE EUR*
Spanner for tamperproof hardware set with interchangeable pins, 16-piece	S1464	69,90

GENERATOR BIT SET, 1/2", 13-PIECE

for mounting freewheel belt pulley. For holding the belt pulley using the enclosed 33-teeth sockets.

- ▶ Screwdriver bits with hexagon drive:
- ▶ Hexagon 8, 10 mm
- ▶ XZN tripe square M8, M10
- ▶ T-profile T40, T50
- ▶ 2 firmly mounted bits T50 and M10
- ▶ Special sockets for Bosch, Valeo, Delco

For universal use on VAG, BMW, Mercedes-Benz, Ford, Renault and others.



DESCRIPTION	ARTICLE	PRICE EUR*
Generator bit set, 1/2", 13-piece	05257L	49,90
Special socket wrench for freewheel pulley, spline, M10	05255L	7,90
Generator multi-purpose key, profil en T, T50	05260L	9,90
Screwdriver bit	05257L-T40	4,30
Screwdriver bit	05257L-T50	4,30
Screwdriver bit, 3/8", spline, M8, long	05222L	4,30
Screwdriver bit, spline, long 10 mm	05223L	4,30
Screwdriver bit, hexagon, long 8 mm	05024L	4,30
Screwdriver bit, hexagon, long 10 mm	05025L	4,70
Special adapter for 10mm screwdriver bits	05600L	5,00

ALTERNATOR MOUNTING SET, 1/2", 22-PIECE

for mounting the freewheel pulley.

Holding the pulley by means of the enclosed 33-tooth inserts and a 31-tooth insert, e.g. For Ford.

Content:

- ▶ Screwdriving bits with hexagon drive:
- ▶ Hexagonal 8, 10 mm
- ▶ XZN tripe square M8, M10
- ▶ T-profile T40, T50
- ▶ 2 fixed bits T50 and M10
- ▶ Special adapter for almost all vehicle types, e.g. For Mercedes, BMW, Ford, VAG, Fiat, Renault, Porsche, Vauxhall, Toyota (allocation list included)



DESCRIPTION	ARTICLE	PRICE EUR*
Alternator mounting set, 1/2", 22-piece	05275L	59,90
Special socket wrench for freewheel pulley, spline, M10	05255L	7,90
Generator multi-purpose key, profil en T, T50	05260L	9,90
Screwdriver bit	05257L-T40	4,30
Screwdriver bit	05257L-T50	4,30
Screwdriver bit, hexagon, long 8 mm	05024L	4,30
Screwdriver bit, hexagon, long 10 mm	05025L	4,70
Screwdriver bit, 3/8", spline, M8, long	05222L	4,30
Screwdriver bit, spline, long 10 mm	05223L	4,30
Special adapter for 10mm screwdriver bits	05600L	5,00

SPECIAL SOCKET WRENCH FOR FREEWHEEL PULLEY, SPLINE, M10

for mounting freewheel belt pulley. The belt pulley is held by 33 tooth-insert.



DESCRIPTION	LENGTH	ARTICLE	ARTICLE SB
Special socket wrench for freewheel pulley, spline, M10	115 mm	05255L	05255SB
Generator multi-purpose key, profil en T, T50	115 mm	05260L	05260SB

TORQUE REPRODUCER, FORD

for loosening and tightening the central fixing sprocket of the crankshaft pulley.

The torque multiplier has a gear ratio of 1: 5. The tool is mandatory when working on the following Ford engines:

- ▶ 1.0 EcoBoost
- ▶ 1.0 Duratec
- ▶ 1.1 Duratec
- ▶ 2.0 Duratorq-TDCi
- ▶ 2.0 EcoBlue Diesel

Suitable for the following vehicles:

- ▶ B-Max 01/12-
- ▶ C-Max 04/10-
- ▶ Ecosport 05/12-
- ▶ Fiesta 05/12-
- ▶ Focus 01/18-
- ▶ Mondeo 10/14-
- ▶ Transit Connect 02/13-

▶ Transit 08/13-

Used equivalent to the following OE numbers:

- ▶ 303-1611
- ▶ 303-1611-01
- ▶ 303-1611-02

NEW
PRODUCT



DESCRIPTION	ARTICLE	PRICE EUR*
Torque reproducer, Ford	26220L	349,90
Torque reproducer	26220L-1	860,60
Torque arm with screws	26220L-2	195,60
Holding plate with screws	26220L-3	139,90
IMPACT socket 3/4", 21 mm	26220L-4	84,20
IMPACT socket 3/4", 24 mm	26220L-5	84,20

ENGINE ADJUSTMENT TOOL SET, FORD

suitable for 1.0 l EcoBoost 3-cylinder petrol engines from 2012 in the following vehicles: Ford: B-Max, C-Max, Fiesta, Ecosport, Focus, Grand C-Max, Transit Courier, Transit Connect, Tourneo Connect

Engine codes:

M1CA, M1CB, M1DA, M1DC, M1DD, M1DH, M1JA, M1JC, M1JE, M1JH, M1JJ, M1JL, M1JM, M2DA, M2DB, M2DC, M2GA, M2GB, P4JA, P4JB, P4JC, P4JD, Q0JA, Q0JB, Q0JC, Q0JD, SFCA, SFCB, SFCC, SFCD, SFDA, SFDB, SFJA, SFJB, SFJC, SFJD, SFJE, SFJF, SFJH, SFJJ, SFJK, SFJL, SFJN, SFJP, XMJA, XMJB, YYJA, YYJB, YYJC, YYJD, YYJE

Used equivalent to the following OE numbers:

- ▶ Rig pin 303-732
- ▶ Timing belt tensioner locking pin 303-1054
- ▶ Flywheel retainer tool 303-1602
- ▶ Sealing ring installation tool 303-1603
- ▶ Crankshaft setting pin 303-1604
- ▶ Camshaft retainer tool 303-1605
- ▶ Arrester tool 303-1606
- ▶ Sealing ring installation tool 303-1636
- ▶ Peg T10060A



DESCRIPTION	ARTICLE	PRICE EUR*
Engine adjustment tool set, Ford	26230L	219,90
Camshaft assembly tool	26230L-1	160,60
Camshaft removal tool	26230L-2	126,20
Camshaft assembly tool	26230L-3	174,90
Camshaft removal tool	26230L-4	174,90
Crankshaft locking tool	26230L-5	17,20
Locking pin crankshaft	26361L-1	6,80
Sealing ring installation tool	26230L-6	60,20
Crankshaft seal installation tool	26230L-7	57,40
Flywheel retainer tool	26230L-8	81,70
Locking pin tensioner V-ribbed belt	26318L-6	2,90
Fixing tool equalising shaft, ø 4 mm	26230L-9	11,50
Fixing tool equalising shaft, ø 8 mm	26230L-10	16,10

GUIDE BOLT LOCK CARRIER, AUDI/VW

for moving the lock carrier to bring the front end into the service position. There is no need to adjust the bonnet lock and the gap dimensions.

Installed in the following vehicles:

- ▶ Audi A4 '94-'01, A4 '00-'08, A6 '97-'05, A6 '04-'11, A8 '94-'02, A8 '02-'09
- ▶ VW Passat '97-'00

Used equivalent to the following OE numbers:

- ▶ VAG 3369



DESCRIPTION	ARTICLE	PRICE EUR*
Guide bolt lock carrier, Audi/VW	26384L	24,90

ENGINE ADJUSTMENT TOOL SET, VW/SKODA/SEAT

for professional engine repair with 1.0 / 1.2 / 1.4 / 1.5 TSI and TFSI as well as 1.6 MPI engines.

Suitable for the following vehicles:

- ▶ Audi A1 (2010-2018), A3 (2012-), A4 (2015-), A5 (2016-), Q2 (2016-), Q3 (2011-)
- ▶ Seat Alhambra (2010-), Ateca (2016-), Ibiza (2008-2017), Ibiza (2016-), Leon (2012-), Mii (2011-), Toledo (2012-)
- ▶ Skoda Citigo (2011-), Fabia (2014-), Kodiaq (2016-), Octavia (2012-), Rapid (2012-), Superb (2015-), Yeti (2009-2017)
- ▶ VW Beetle (2011-), Caddy (2015-), CC (2011-2016), Golf VII (2012-), Jetta (2009-), Passat (2014-), Polo (2009-), Scirocco (2008-2017), Sharan (2010-), Tiguan (2007-2016), Tiguan (2016-), Touran (2015-), up! (2011-)

Engine Codes:

CHPA, CHPB, CHYA, CHYB, CHYC, CHZA, CHZB, CHZC, CHZD, CHZE, CHZF, CHZG, CHZJ, CHZK, CHZL, CJZA, CJZB, CJZC, CJZD, CMBA, CNLA, CPGA, CPTA, CPVA, CPVB, CPWA, CRJA, CSSA, CUKB, CUKC, CVNA, CWLA, CWVA, CWVB, CXSA, CXSB, CXUA, CYVA, CYVB, CYVC, CYVD, CZCA, CZCB, CZCC, CZDA, CZDB, CZDD, CZEA, CZTA, DACA, DADA, DAFA, DBWA, DDHA, DJVA, DKJA

Used equivalent to the following OE numbers:

- ▶ T10340
- ▶ T10476
- ▶ T10477



DESCRIPTION	ARTICLE	PRICE EUR*
Engine adjustment tool set, VW/Skoda/Seat	26400L	89,90
Locking pin crankshaft	26352L-3	7,90
Locking tool camshaft	26400L-1	21,40
Locking tool camshaft	26400L-2	95,60
Locking tool camshaft	26400L-3	98,50
Spanner tensioning pulley	26400L-4	32,80
Locking tool camshaft	26400L-5	214,20
Adjusting tool tensioner, 6 mm	26357L-6	2,40
Locking pin tensioner V-ribbed belt	26357L-5	1,90

GUIDE PIN SET, M8 AND M10, 4-PIECE

The guide bolts allow the front mask (lock carrier) to be pushed away from the engine without dismantling the hoses. They are used instead of the front mask screws.

- ▶ Setting the service position is made possible
- ▶ Helpful e.g. when working on camshafts or changing timing belts
- ▶ Adjusting the hood lock and the gap dimensions is not necessary

Content:

- ▶ 4 guide bolts:
- ▶ 2 x M8
- ▶ 2 x M10

Used equivalent to OE numbers VAG3411 and T10093.



DESCRIPTION	ARTICLE	PRICE EUR*
Guide pin set, M8 and M10, 4-piece	26314L	24,90

ENGINE TIMING TOOL SET, VAG

Very comprehensive universal set for vehicles with VAG petrol and diesel engines. Includes tools for locking the flywheel, crankshaft and camshaft and for adjusting the timing belt tension.

**NEW
PRODUCT**

Installed in the following vehicles:

- ▶ Audi A1, A2, A3, A4, A5, A6, A8, Q3, Q5, TT, Coupe, Cabriolet, 80, 100
- ▶ Ford Galaxy
- ▶ Mitsubishi Lancer
- ▶ Seat Alhambra, Altea, Arosa, Cordoba, Exeo, Ibiza, Inca, Leon, Toledo
- ▶ Škoda Fabia, Felicia, Octavia, Rapid, Roomster, Superb, Yeti
- ▶ VW Amarok, Beetle, Bora, Caddy, Eos, Fox, Golf, Jetta, Lupo, Passat, Polo, Scirocco, Sharan, Tiguan, Touran, Vento, LT, Transporter

Engine codes: 1G, 1S, 1T, 1V, 1W, 1X, 1Y, 1Z, 3D, AAB, AAH, AAS, AAT, AAZ, ABC, ABL, ABP, ACK, ACL, ACT, ACV, ADR, AEB, AEF, AEJ, AEL, AEY, AFB, AFF, AFK, AFN, AFY, AGA, AGD, AGE, AGN, AGP, AGR, AGU, AGX, AHA, AHB, AHD, AHF, AHG, AHH, AHU, AHW, AHY, AJA, AJG, AJH, AJK, AJL, AJM, AJP, AJQ, AJT, AJV, AKC, AKE, AKF, AKN, AKQ, AKU, AKW, ALE, ALF, ALG, ALH, ALT, ALW, ALZ, AMB, AMF, AMK, AML, AMM, AMX, ANB, ANJ, ANK, ANM, ANU, ANY, APA, APC, APE, APG, APH, APP, APR, APS, APT, APU, APX, APY, APZ, AQA, AQD, AQE, AQF, AQG, AQH, AQJ, AQQ, AQX, ARC, ARE, ARG, ARH, ARJ, ARK, ARL, ARN, ARR, ARS, ART, ARU, ARX, ARY, ARZ, ASG, ASJ, ASM, ASV, ASX, ASY, ASZ, ATC, ATD, ATJ, ATL, ATN, ATQ, ATW, ATX, AUA, AUB, AUF, AUG, AUL, AUM, AUQ, AUS, AUW, AUX, AUY, AVB, AVC, AVF, AVG, AVJ, AVP, AVQ, AVR, AVV, AVY, AWC, AWD, AWM, AWN, AWP, AWT, AWU, AWV, AWW, AWX, AWY, AXB, AXC, AXG, AXL, AXP, AXR, AYC, AYM, AYP, AYQ, AYS, AYY, AYZ, AZA, AZD, AZQ, AZR, AZV, BAD, BAM, BAU, BAY, BBD, BBE, BBF, BBG, BBM, BBU, BBY, BBZ, BCA, BCB, BCS, BCY, BCZ, BDG, BDH, BDJ, BDK, BDV, BEA, BEE, BES, BEW, BEX, BFB, BFC, BFL, BFM, BFV, BGK, BGW, BHC, BHW, BJB, BJX, BKC, BKD, BKE, BKF, BKP, BKV, BKY, BLB, BLS, BLT, BLZ, BMA, BMD, BME, BMM, BMN, BMP, BMR, BMS, BMT, BNA, BNM, BNU, BNV, BPW, BPX, BPZ, BRB, BRC, BRD, BRE, BRF, BRR, BRS, BRT, BRU, BRV, BSS, BST, BSU, BSV, BSW, BTB, BUD, BUK, BUZ, BVA, BVE, BVF, BVG, BVH, BVK, BVP, BVR, BWB, BWV, BXE, BXF, BXJ, BXV, BXW, BZG, CAAA, CAAB, CAAC, CAAD, CAAE, CAGA, CAGB, CAGC, CAHA, CAHB, CAYA, CAYB, CAYC, CAYD, CAYE, CBAA, CBAB, CBAC, CBBA, CBBB, CBDA, CBDB, CBDC, CBEA, CCHA, CCHB, CDBA, CDCA, CDDA, CEGA, CEVA, CFCA, CFFA, CFFB, CFFD, CFFE, CFGC, CFGD, CFHA, CFHB, CFHC, CFHD, CFHE, CFHF, CFJA, CFJB, CFMA, CFWA, CGGA, CGGB, CGLA, CGLB, CGLC, CGLD, CGLE, CGPA, CGPB, CGPC, CHFA, CHFB, CHTA, CJAA, CJCA, CJCB, CJCC, CJCD, CJLB, CLCA, CLCB, CLJA, CLLA, CLLB, CLNA, CLPA, CMEA, CMFA, CMFB, CMGA, CMGB, CNEA, CNFA, CNFB, CSHA



DESCRIPTION	ARTICLE	PRICE EUR*
Engine timing tool set, VAG	26383L	149,90
Locking pin set	26383L-1	5,90
Locking pin	26383L-2	2,50
Locking pin	26383L-3	3,90
Locking pin	26383L-4	3,90
Tensioning screw	26375L-3	4,90
Guide bolt lock carrier, Audi/VW	26384L	24,90
Adjusting tool tensioner	26385L	12,90
Adjusting tool tensioner	26383L-6	14,90
Locking pin tensioner	26352L-4	2,90
Locking tool camshaft	26383L-7	3,90
Locking tool camshafts	26383L-8	8,90
Adjusting tool tensioner, 6 mm	26357L-6	2,40
Locking tool camshaft	26354L-2	14,50
Tensioning tool chain tensioner	26375L-4	5,90
Locking tool camshafts	26354L-1	19,90
Locking pin crankshaft	26354L-3	12,90
Locking pin crankshaft	26383L-9	9,90
Locking pin injection pump	26383L-10	5,90
Locking plate tensioner	26366L	3,90
Locking pin camshaft/fuel pump	26367L	11,16
Locking tool camshaft	26383L-11	14,90
Locking tool camshafts	26386L	12,90
Locking pin tensioner V-ribbed belt	26357L-5	1,90
Locking pin tensioner	26357L-4	3,50
Locking tool crankshaft	26368L	11,90
Locking tool crankshaft	26369L	11,90
Locking tool camshafts	26383L-12	12,90

ENGINE TIMING TOOL SET, VAG

The complete tool set contains almost all crankshaft and camshaft locking tools as well as comprehensive installation aids such as adjustable tamperproof spanners and radiator grille tools.

- ▶ 3-cylinder
- ▶ 4-cylinder
- ▶ 6-cylinder
- ▶ 8-cylinder

Includes important tools such as:

- ▶ Adjustment gauge for camshaft (eg VW 1.9l TDI)
- ▶ Timing Belt Wheel Locking Tool (e.g., VW / Škoda 1.9l / 2.0l TDI Pump / Nozzle)
- ▶ Locking tool for camshaft (eg VW / Audi 2.5l V6 TDI)
- ▶ Timing belt tensioner wrench 3-way adjustable (univ. For VW / Audi)
- ▶ Injector impeller locking arbor (e.g., VW / Audi / Seat / Škoda, etc.)
- ▶ Holding plate for timing belt tensioning device (VW / Škoda 4 cylinder TDI pump / nozzle)
- ▶ Open plug-in insert with wrench size 22 for disassembly / assembly of diesel injectors



DESCRIPTION	ARTICLE	PRICE EUR*
Engine timing tool set, VAG	26057L	142,90
Camshaft locking pin, 2-piece	26057L-4	46,50
Crankshaft locking pin	26057L-5	19,50
Retaining plate	26081L	3,50
Locking tool, VAG	26084L	41,20
Locking tool set, V engines	26086L	11,50
Radiator grille removal aid, 2-piece	10108L	47,90
Injector loosening wrench	26057L-12	32,50
Crankshaft retainer tool	26057L-6	12,90
Camshaft setting gauge	26057L-18	6,90
Bolt	26057L-15	2,90
Camshaft locking pin	26057L-8	5,50

ENGINE TIMING TOOL SET, VAG

contains the most important tools for repair work on 1.2l VAG engines with 2- and 4-valve technology..

Suitable for the following vehicles:

- ▶ Seat Cordoba '02-'08, Ibiza III '02-'08, Ibiza IV '08-'17, Toledo IV '12-'19
- ▶ Škoda Fabia I '99-'07, Fabia II '07-'14, Rapid NH, Roomster '06-'10
- ▶ VW Fox '05-'11, Polo IV '01-'09, Polo V '09-'17

Engine codes: AWY, AZQ, BBM, BMD, BME, BXV, BZG, CEVA, CGPA, CGPB, CGPC, CHFA, CHFB, CHTA, CJLA, CJLB

Used equivalent to the following OE numbers:

- ▶ Locking tool camshafts, VAG T10123
- ▶ Locking tool camshaft, VAG T10120
- ▶ Locking pin crankshaft, VAG T10121



DESCRIPTION	ARTICLE	PRICE EUR*
Engine timing tool set, VAG	26354L	44,90
Locking tool camshafts	26354L-1	19,90
Locking tool camshaft	26354L-2	14,50
Locking pin crankshaft	26354L-3	12,90

ENGINE TIMING TOOL SET, VAG

contains the most important tools for repair work on 1.2 TSI and TFSI VAG engines with timing chain.

Suitable for the following vehicles:

- ▶ Audi A1 '10-'15, A3 '10-'13
- ▶ Seat Altea/XL '10-, Ibiza IV '10-'15, Leon '12-'15, Toledo IV '12-'15
- ▶ Škoda Fabia II '10-'14, Octavia II '10-'13, Rapid '12-'15, Roomster '10-'15, Yeti '09-'15
- ▶ VW Beetle '11-'19, Caddy III '10-'15, Golf VI '09-'16, Golf Plus '09-'14, Jetta IV '10-'17, Polo V '09-'14, Touran '10-'15

Engine codes: CBZA, CBZB, CBZC

Used equivalent to the following OE numbers:

- ▶ Locking tool camshaft, VAG T10414
- ▶ Guide pin (2 pieces), VAG T10341
- ▶ Locking pin crankshaft, VAG T10340



DESCRIPTION	ARTICLE	PRICE EUR*
Engine timing tool set, VAG	26360L	29,90
Locking pin crankshaft	26352L-3	7,90
Locking tool camshaft	26360L-1	15,50
Guide pin (2 pieces)	26360L-2	6,90

LOCKING TOOL CAMSHAFTS

for professional locking of the camshafts on 1.4 and 1.6 16V VAG petrol engines.

Installed in the following vehicles:

- ▶ Audi A2 '99-'05
- ▶ Seat Altea '04-'15, Arosa '97-'04, Cordoba '93-'02, Cordoba '02-'08, Ibiza '93-'02, Ibiza '02-'08, Ibiza '08-'15, Inca '95-'03, Leon '99-'06, Leon '05-'12, Toledo '98-'04, Toledo '04-'09
- ▶ Škoda Fabia '99-'07, Fabia '07-'14, Octavia '96-'04, Octavia '12-'20, Roomster '06-'15
- ▶ VW Bora '98-'05, Caddy '95-'03, Caddy '03-'15, Golf IV '97-'03, Golf V '03-'08, Golf VI '08-'12, Lupo '98-'05, New Beetle '97-'10, Polo '94-'01, Polo '01-'09, Polo '09-'14

Engine codes: AFK, AHW, AJV, AKQ, APE, AQQ, ARC, ARR, ATN, AUA, AUB, AUS, AVY, AXP, AZD, BAD, BBY, BBZ, BCA, BCB, BKY, BUD, BXW, CDDA, CGGA, CGGB, CLPA

Used equivalent to the following OE numbers:

- ▶ VAG T10016
- ▶ VAG T10074



NEW
PRODUCT

DESCRIPTION	ARTICLE	PRICE EUR*
Arretierwerkzeug Nockenwellen	26386L	12,90

ENGINE TIMING TOOL SET, VAG

contains the most important tools for repair work on 1.4 and 1.6 l VAG FSI, TSI and TFSI engines.

Suitable for the following vehicles:

- ▶ Audi A1 '14-'18, A3 '03-'13
- ▶ Seat Alhambra '10-'22, Altea '04-'15, Cordoba '06-'09, Ibiza III '02-'08, Ibiza IV '08-'15, Leon '07-'12, Toledo III '04-'09, Toledo IV '12-'19
- ▶ Škoda Fabia II '07-'14, Octavia II '04-'13, Rapid '12-'17, Roomster '06-'15, Superb II '08-'15, Yeti '09-'17
- ▶ VW Beetle '11-'19, Eos '06-'15, Golf V '03-'09, Golf VI '08-'16, Jetta III '05-'10, Jetta IV '10-'18, Passat '05-'14, CC '12-'16, Polo IV '01-'09, Polo V '09-'17, Scirocco III '08-'17, Sharan '10-'22, Tiguan '07-'18, Touran I '10-'15

Engine codes: AXU, BAG, BKG, BLF, BLG, BLN, BLP, BMY, BTS, BWK, CAVA, CAVB, CAVC, CAVD, CAVE, CAVF, CAVG, CAXA, CAXC, CDGA, CFNA, CFNB, CKMA, CLRA, CLSA, CMSA, CMSB, CNUB, CNVA, CNWA, CNWB, CTHA, CTHB, CTHC, CTHD, CTHE, CTHF, CTHG, CTJB, CTJC, CTKA

Used equivalent to the following OE numbers:

- ▶ TDC dial gauge adapter, VAG T10170A
- ▶ Locking tool camshafts, VAG T10171, T10171A, T10171B
- ▶ Locking pin crankshaft, VAG T10340
- ▶ Locking pin tensioner, VAG T40011



DESCRIPTION	ARTICLE	PRICE EUR*
Engine timing tool set, VAG	26352L	74,90
TDC dial gauge adapter	26352L-1	39,90
Locking tool camshafts	26352L-2	27,90
Locking pin crankshaft	26352L-3	7,90
Locking pin tensioner	26352L-4	2,90

COUNTERHOLDER CAMSHAFT AND CRANKSHAFT

Especially for counterholding camshafts, camshaft phasers and cardan shafts. Due to the enclosed screw-in adapters, this set can be used on the majority of VAG vehicles.

Suitable for the following vehicles:

- ▶ Audi: A1 (8X), A2 (8Z), A3 (8P, 8V), A4 (8E, 8K), A5 (8T), A6 (4B, 4F, 4G), A7 (4GA, 4GF), A8 (4E, 4H), Cabrio (8H), Q2 (GH), Q3 (8U), Q5 (8R), Q7 (4L, 4M), R8 (4z), TT (8J, FV)
- ▶ Seat: Alhambra (710, 711), Altea (5P), Arona (KJ7), Ateca (KH7), Cordoba (6L), Exceo (3R), Ibiza (6L, 6P, KJ), Leon (1P, 5F), Mii (KF1), Toledo (5P, KG3)
- ▶ Škoda: Citigo (NF), Fabia (6Y, 54, NJ), Kodiaq (NS7), Octavia (1U, 1Z, 5E), Rapid (NH), Roomster (5J), Superb (3U, 3T, 3V), Yeti (5L)
- ▶ VW: Amarok (2H), Arteon (3H), Beetle (1Y, 5C), Bora (1J), Caddy (9K, 2C, SA), EOS (1F), Fox (5Z), Golf (1J, 1K, 5K, 5G), Jetta (AV), Passat (3C, 3G), CC (358), Phaeton (3D), Polo (9N, 6R), Scirocco (13), Sharan (7N), Tiguan (5N), Touareq (7L, 7P), Touran (1T, 5T), Transporter (7H), Up! (12), XL1

Used equivalent to the following OE numbers:

- ▶ Camshaft and crankshaft counterholder, OE number T10172
- ▶ Adapter camshaft phaser, OE number T10554



DESCRIPTION	ARTICLE	PRICE EUR*
Counterholder camshaft and crankshaft	26371L	204,90
Counterholder	26371L-1	123,70
Adapter camshaft sprocket	26371L-2	49,90
Spare bolt counterholder	26371L-3	9,90
Spare bolt counterholder	26371L-4	9,90
Spare bolt counterholder	26371L-5	9,90
Spare bolt counterholder	26371L-6	9,90
Spare bolt counterholder	26371L-7	9,90
Spare bolt counterholder	26371L-8	9,90
Spare bolt counterholder	26371L-9	9,90
Spare bolt counterholder	26371L-10	9,90
Spare bolt counterholder	26371L-11	9,90
Spare bolt Counterholder	26371L-12	9,90

FITTING TOOL FOR VAG PULLEY, VAG

for fitting and removing the pulley on 4-cylinder 1.8l and 2.0l, 4V TFSI direct injection engines.

Suitable for the following vehicles:

- ▶ Audi: A1 (2010-), A3 (2003-2013), A3 (2012-), A4 (2007-2016), A4 (2015-), A5 (2016-), A5 Cabrio (2009-), A6 (2010-), A8 (2009-), Q2 (2016-), Q3 (2011-), Q5 (2008-2016), Q5 (2016-), Q7 (2015-), TT (2006-2014), TT (2014-)
- ▶ Seat: Alhambra (2010-), Altea (2004-), Altea XL (2006-), Ateca (2016-), Ibiza (2016-), León (2006-2012), León (2012-), Toledo (2004-2009), Toledo (2009-)
- ▶ Škoda: Kodiaq (2016-), Octavia II (2004-2013), Octavia III (2012-), Superb II (2008-2015), Superb III (2015-), Yeti (2009-)
- ▶ VW: Amarok (2010-), Arteon (2010-), Beetle (2011-), CC (2011-), EOS (2006-2015), Golf V (2003-2009), Golf VI (2008-), Golf VII (2012-), Jetta (2012-), Passat (2005-2011), Passat (2010-2014), Passat (2014-), Polo (2009-2017), Scirocco (2008-), Sharan (2010-), Tiguan (2007-2016), Tiguan (2016-), Touran (2015-), Transporter (2010-)

Engine codes:

BPU, BYT, BZB, CABA, CABB, CABD, CADA, CAEA, CAEB, CAED, CAWA, CAWB, CBFA, CCTA, CCTB, CCUA, CCZA, CCZB, CCZC, CCZD, CDAA, CDAB, CDHA, CDHB, CDNB, CDNC, CDZA, CESA, CETA, CFKA, CFPA, CGMA, CGYA, CHHA, CHHB, CHHC, CHJA, CJEB, CJED, CJEE, CJHA, CJHB, CJKA, CJKB, CJSB, CJSB, CJSB, CJXA, CJXB, CJXC, CJXD, CJXE, CJXF, CJXG, CJXH, CNCB, CNCD, CNCE, CNSB, CNTA, CNTC, CPEA, CPKA, CPLA, CPMA, CPMB, CPPA, CPRA, CPSA, CRHA, CUFA, CUHA, CUHB, CUJA, CULA, CULB, CULC, CVKB, CWNA, CWPB, CWZA, CXDA, CXDB, CYFB, CYGA, CYJA, CYMC, CYNB, CYPA, CYPB, CYRB, CYRC, CYYA, CZPA, CZPB, CZRA, DAJA, DAJB, DAXB, DAXC, DAYB, DBFB, DBPA, DBRA, DDWA, DEDA, DHGA, DJHA, DJHB, DJHC, DJJA, DLBA, DLRA

Used equivalent to OE number T10531.

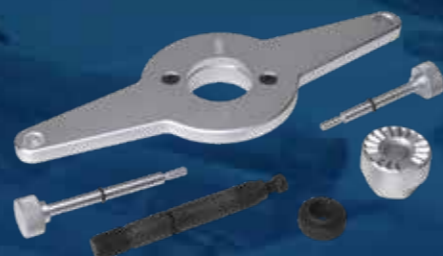

DESCRIPTION	ARTICLE	PRICE EUR*
Fitting tool for VAG pulley, VAG	26184L	159,90
Alignment tool from set 26184L	26184L-1	162,50

FITTING TOOL FOR VAG PULLEY, VAG

DESCRIPTION	ARTICLE	PRICE EUR*
Crankshaft sprocket holding tool	26184L-2	55,90
Adapter	26184L-3	26,90
Crankshaft sprocket holding tool nut	26184L-4	16,50
Screw set	26184L-5	35,00

ASSEMBLY LEVER CHAIN TENSIONER, VAG

for pushing back the chain tensioner during engine repair work, e.g. when replacing the timing chain on VAG vehicles with 4-cylinder 1.8 and 2.0 4V TFSi direct injection engines.

Engine code: BPU, BYT, BZB, CABA, CABB, CABD, CADA, CAEA, CAEB, CAED, CAWA, CAWB, CBFA, CCTA, CCTB, CCUA, CCZA, CCZB, CCZC, CCZD, CDAA, CDAB, CDHA, CDHB, CDNB, CDNC, CDND, CDZA, CESA, CETA, CFKA, CGMA, CGYA, CHHA, CHHB, CHHC, CHJA, CJEB, CJED, CJEE, CJHA, CJHB, CJKA, CJKB, CJSB, CJSB, CJSC, CJXA, CJXB, CJXC, CJXD, CJXE, CJXF, CJXG, CJXH, CNCB, CNCD, CNCE, CNSB, CNTA, CNTC, CPEA, CPKA, CPLA, CPMA, CPMB, CPPA, CPRA, CPSA, CRHA, CUFA, CUHA, CUHB, CUJA, CULA, CULB, CULC, CVJA, CVKB, CWNA, CWPB, CWZA, CXDA, CXDB, CYFB, CYGA, CYMC, CYNB, CYPA, CYPB, CYRB, CYRC, CYYA, CZPA, CZPB, CZRA, DAJA, DAJB, DAXB, DAXC, DAYB, DBFB, DBPA, DBRA, DDWA, DEDA, DHGA, DJHA, DJHB, DJHC, DJJA, DLBA, DLRA Used equivalent to OE number T40243.



DESCRIPTION	ARTICLE	PRICE EUR*
Assembly lever chain tensioner, VAG	26174L	64,90

ASSEMBLY TOOL CAMSHAFT ADJUSTMENT, VAG

removal and assembly tool for the control valve of the camshaft adjustment at Audi 1.8 l / 2.0 l TFSI/TFSI 4 cylinder engines with timing chain. Suitable for the following vehicles:

- ▶ Audi A1 (2010-), A3 (2003-), A3 (2012-), A4 (2007-), A4 (2015-), A5 (2007-), A5 (2016-), A6 (2010-), A8 (2009-), Q2 (2016-), Q3 (2011-), Q5 (2008-), Q5 (2016-), Q7 (2015-), TT (2006-), TT (2014-)
- ▶ Seat Alhambra (2010-), Altea (2004-), Ateca (2016-), Exeo (2008-), Ibiza (2016-), León (2005-), León (2012-), Toledo (2004-), Toledo (2009-)
- ▶ Skoda Kodiaq (2016-), Octavia II (2004-), Octavia III (2012-), Superb II (2008-), Superb III (2015-), Yeti (2009-)
- ▶ VW Amarok (2010-), Arteon (2017-), Beetle (2011-), CC (2011-), EOS (2006-), Golf V (2003-), Golf VI (2008-), Golf VII (2012-), Jetta (2009-), Passat (2005-), Passat (2010-), Passat (2014-), Polo (2009-), Scirocco (2008-), Sharan (2010-), Tiguan (2007-), Tiguan (2016-), Touran (2015-), Transporter T5 (2003-), Transporter T6 (2015-)

Engine codes:

BPU, BYT, BZB, CABA, CABB, CABD, CADA, CAEA, CAEB, CAED, CAWA, CAWB, CBFA, CCTA, CCTB, CCUA, CCZA, CCZB, CCZC, CCZD, CDAA, CDAB, CDHA, CDHB, CDNB, CDNC, CDND, CDZA, CESA, CETA, CFKA, CFPA, CGMA, CGYA, CHHA, CHHB, CHHC, CHJA, CJEB, CJED, CJEE, CJHA, CJHB, CJKA, CJKB, CJSB, CJSB, CJSC, CJXA, CJXB, CJXC, CJXD, CJXE, CJXF, CJXG, CJXH, CNCB, CNCD, CNCE, CNSB, CNTA, CNTC, CPEA, CPKA, CPLA, CPMA, CPMB, CPPA, CPRA, CPSA, CRHA, CUFA, CUHA, CUHB, CUJA, CULA, CULB, CULC, CVJA, CVKB, CWNA, CWPB, CWZA, CXDA, CXDB, CYFB, CYGA, CYMC, CYNB, CYPA, CYPB, CYRB, CYRC, CYYA, CZPA, CZPB, CZRA, DAJA, DAJB, DAXB, DAXC, DAYB, DBFB, DBPA, DBRA, DDWA, DEDA, DHGA, DJHA, DJHB, DJHC, DJJA, DLBA, DLRA

Uses equivalent to the following OE numbers:

- ▶ T10352
- ▶ T10352/1A
- ▶ T10352/2
- ▶ T10352/3
- ▶ T10352/4
- ▶ T10352C



DESCRIPTION	ARTICLE	PRICE EUR*
Assembly tool camshaft adjustment, VAG	26312L	49,90

SPECIAL SOCKET, 1/2", VAG

For loosening and tightening the camshaft adjuster mounting bolt on VAG vehicles.



Suitable for:

- ▶ Audi A1 (2010-2018), A3 (2003-2015), A4 (2000-2008), A6 (2004-2011), TT (2006-2015)
- ▶ Seat Altea (2004-2016), Exeo (2008-2014), León (2005-2013), Toledo (2004-2009)
- ▶ Skoda Octavia II (2004-2013)
- ▶ VW Eos (2006-2015), Golf V (2003-2009), Golf VI (2009-2016), Jetta (2004-2010), Passat (2005-2011), Polo (2009-), Scirocco (2008-2017), Touran (2003-2015)

Engine: AWA, AXW, AXX, BGB, BHD, BHZ, BLR, BLX, BLY, BMB, BPG, BPJ, BPY, BUL, BVX, BVY, BVZ, BWA, BWE, BWJ, BWT, BYD, BYK, BZC, CDLA, CDLB, CDLC, CDLD, CDLF, CDLG, CDLH, CDLJ, CDLK, CDMA, CRZA

Used equivalent to OE number T40080.

DESCRIPTION	ARTICLE	PRICE EUR*
Special socket, 1/2", VAG	40080L	8,90

ENGINE ADJUSTMENT TOOL SET, VAG

for professional engine servicing on 1.8 / 2.0 l FSi/TFSi/TSi 4 cylinder petrol engines, used in the following vehicles:

- ▶ Audi A1 (8X), A3 (8P), A4 (8E, 8K), A5 (8T, 8F), A6 (4F, 4G), A7 (4G), A8 (4H), Q3 (8U), Q5 (8R), TT (8J, FV)
- ▶ Seat Alhambra, Altea (5P), Exceo (3R), Leon (1P, 5F), Toledo (5P)
- ▶ Skoda Octavia (1Z, 5E), Superb (3T), Yeti (5L)
- ▶ VW Amarok (2H), Beetle (5C), CC (358), EOS (1F), Golf (1K, 5K, 5G), Jetta (1K, 16), Passat (3C, 36), Passat CC (35), Polo (6R), Scirocco (13), Sharan (7N), Tiguan (5N), Touran (1T), Transporter T5 (7H, 7E), Transporter T6 (5G, 5F)

Engine codes: BYT, BZB, CABA, CABB, CABD, CAEA, CAEB, CAED, CAWA, CAWB, CBFA, CCTA, CCTB, CCZA, CCZB, CCZC, CCZD, CDAA, CDAB, CDHA, CDHB, CDNB, CDNC, CDND, CESA, CETA, CFKA, CFPA, CGYA, CHHA, CHHB, CHHC, CHJA, CJEB, CJED, CJEE, CJK, CJKB, CJSA, CJSB, CJSJ, CJXA, CJXB, CJXC, CJXD, CJXE, CJXF, CJXG, CJXH, CNCB, CNCD, CNCE, CNSB, CNTA, CNTC, CPKA, CPLA, CPMA, CPMB, CPPA, CPRA, CPSA, CULA, CULB, CULC, CVKB, CVKC, CVLA, CWZA, CXCB, CXDA, CXDB, CYFB, CYGA, CYMC, CYNB, CYPA, CYPB, CYRB, CYRC, CZPA, CZPB, CZPC, DAJA, DAJB, DAXB, DAXC, DAYB, DBPA, DDWA, DEDA, DEMA, DEMB, DGUA, DGVA, DHDA, DHGA, DJHA, DJHB, DJHC, DJYA, DKNA, DKTA, DKTB, DKTC, DKYA, DKZA, DKZB, DKZC, DLBA, DLGA, DLHA, DLHB, DLRB, DLVA, DLVB, DMFA, DMFB, DMSA, DMSB, DMTA, DMTC, DNEA, DNFB, DNFC, DNFE, DNFG, DNJA, DNLA, DNNA, DNNB, DNND, DNPA, DNTA, DNUA, DNUC, DNUF, DPAA, DPUA, DPVA, DRFA, DRNB, DRXA, DRYA, DSFE, DSFF, DTEA, DUNA

Used equivalent to the following OE numbers:

- ▶ T10060A
- ▶ T10170A
- ▶ T10352
- ▶ T10352/1
- ▶ T10352/2
- ▶ T10355
- ▶ T10368
- ▶ T10567
- ▶ T40011
- ▶ T40196
- ▶ T40265
- ▶ T40266
- ▶ T40267
- ▶ T40271
- ▶ T40314
- ▶ VAS6079



DESCRIPTION	ARTICLE	PRICE EUR*
Engine adjustment tool set, VAG	26188L	154,90
Locking pin	26188L-1	13,50
Removal tool camshafts control valve	26188L-2	19,90
Removal tool camshafts control valve	26188L-3	22,50
Removal tool camshafts control valve	26188L-4	26,90

ENGINE ADJUSTMENT TOOL SET, VAG

DESCRIPTION	ARTICLE	PRICE EUR*
Locking pin tensioner V-ribbed belt	26357L-5	1,90
Crankshaft thrust piece	26159L-2	15,90
Crankshaft locking tool, VAG	94901L	14,90
Locking pin tensioner	26352L-4	2,90
Drift for camshaft slide	26159L-3	7,90
Locking Clip	26159L-4	5,50
Camshaft clamp	26159L-5	39,90
Precision gauge	26067L	76,90
Adapter, 1/2"	26186L-2	14,90

ENGINE ADJUSTMENT TOOL SET, VAG

for VAG 1.8l and 2.0l TSI / TFSI gasoline engines from '08 with control chain.

Fits:

- ▶ Audi A3, A4, A5, TT, Q5
- ▶ VW Eos, Golf Jetta, Passat, Scirocco, Sharan, Tiguan
- ▶ Seat Altea, Exeo, Leon, Toledo
- ▶ Skoda Octavia II, Superb II, Yeti

Engine codes:

- ▶ BYT, BZB, CABA, CABB, CABD, CAEA, CAEB, CAWA, CAWB, CBFA, CCTA, CCZA, CCZB, CCZC, CCZD, CDAA, CDAB, CDHA, CDHB, CDNB, CDNC, CDND, CESA, CETA, CFKA, CFPA, CGYA, CHHA, CJEB, CJSB, CJSJ, CPMA, CULA

Used equivalent to the following OE numbers:

- ▶ Crank counter hold tool T10355
- ▶ Crankshaft thrust piece T10368
- ▶ Drift for camshaft slide pieces T40196
- ▶ Locking clips T40267
- ▶ Camshaft clamp T40271
- ▶ Assembly tool T10352 and T10352/1



DESCRIPTION	ARTICLE	PRICE EUR*
Engine adjustment tool set, VAG	26159L	109,90
Crank counter hold tool	26159L-1	84,50
Crankshaft thrust piece	26159L-2	15,90
Drift for camshaft slide	26159L-3	7,90
Locking Clip	26159L-4	5,50
Camshaft clamp	26159L-5	39,90
Assembly tool	26159L-6	33,90

ENGINE TIMING TOOL SET, AUDI/VW

for locking the camshaft and crankshaft on 2.0 FSI, TSI and TFSI VAG petrol engines

Installed in the following vehicles:

- ▶ Audi A3 '03-'13, A4 '00-'08, A6 '04-'11, TT '06-'14
- ▶ Seat Altea '04-'15, Exeo '08-'13, Leon '05-'12, Toledo '04-'09
- ▶ Škoda Octavia '04-'13
- ▶ VW Eos '06-'15, Golf V '03-'08, Golf VI '08-'12, Jetta '05-'10, Passat '05-'10, Polo '09-'14, Scirocco '08-'17, Touran '03-'15

Engine codes: AWA, AXW, AXX, BGB, BHZ, BLR, BLX, BLY, BMB, BPG, BPJ, BPY, BUL, BVX, BVY, BVZ, BWA, BWE, BWJ, BWT, BYD, BYK, BZC, CDLA, CDLB, CDLC, CDLD, CDLF, CDLG, CDLH, CDLJ, CDLK, CDMA, CRZA

Used equivalent to the following OE numbers::

- ▶ Camshaft fixation, VAG T10252
- ▶ Adjustment tool tensioning pulley, VAG T10020
- ▶ Tensioning screw chain tensioner, VAG T10092
- ▶ Locking pin tensioning device, VAG T10060Ali>Locking pin tensioning device V-ribbed belt, VAG T10115
- ▶ Chain tensioner camshaft adjuster, VAG 3366
- ▶ Locking pin tensioning pulley, VAG T40011



DESCRIPTION	ARTICLE	PRICE EUR*
Engine timing tool set, Audi/VW	26375L	64,90
Locking tool camshaft	26375L-1	49,90
Adjusting tool tensioner	26375L-2	19,90
Tensioning screw	26375L-3	4,90
Tensioning tool chain tensioner	26375L-4	5,90
Locking pin tensioner V-ribbed belt	26318L-6	2,90
Locking pin tensioner	26352L-4	2,90
Locking pin tensioner V-ribbed belt	26357L-5	1,90

ENGINE ADJUSTMENT TOOL SET, AUDI

Contains important tools e.g. for the following work on Audi with 2.4, 3.2 et 4.2 FSI petrol engines:

- ▶ For locking the cam and crankshaft
- ▶ For fixing the chain tensioning unit
- ▶ For replacing the timing chain
- ▶ For adjusting the timing during engine repairs

Suitable for:

- ▶ Audi A4, A6 of the model series B7 and C6
- ▶ With engine codes: AUK, BDW

Used equivalent to The following OE numbers:

- ▶ Rotary adaptor of the crankshaft T40058
- ▶ Crankshaft fixing device T40069
- ▶ Fixing pin for chain tensioner T40071
- ▶ 2-piece camshaft fixing device T40070

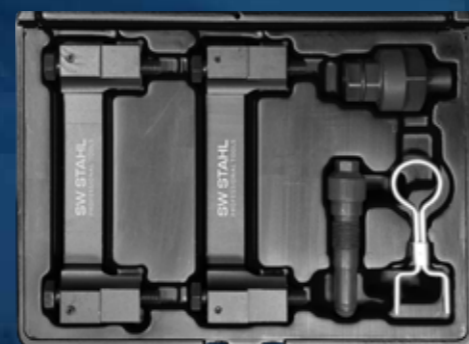

DESCRIPTION	ARTICLE	PRICE EUR*
Engine adjustment tool set, Audi	26133L	135,90

CRANKSHAFT ALIGNMENT RULER

for VW + Audi

- ▶ Motor Code AAA, ABV, AES, AGZ, AMY, AQN, AZX

Suitable for:

- ▶ 2.3 l, 2.8 l and 2.9 l (VR5 and VR6 engines), equivalent to OE 3268



DESCRIPTION	ARTICLE	PRICE EUR*
Crankshaft alignment ruler	26012L	4,90

CAMSHAFT LOCKING TOOL, AUDI/VW

Tool clamp for fixing the camshaft wheels of V engines with one camshaft per cylinder row. For work on the motor control unit e.g. toothed belt work. The clamp can be moved so that both 4-valve and 5-valve engines can be served using the one tool. This avoids additional costs.

Can be used with:

- ▶ Audi 80 (91-95), 100 (90-94), A4 (94-02), A6 (94-97), A6 (97-05), A6 (04-11), A8 (94-05), A8 (02-10), Cabriolet (91-00), Coupé (88-96)
- ▶ Skoda Superb (01-08)
- ▶ VW Passat (96-05), Phaeton (02-16), Touareq (02-13)

Engine codes: AAH, ABC, ACK, ACZ, AEJ, AGA, AGB, AGE, AHA, AJG, AJK, AKB, AKC, ALF, ALG, ALW, AML, AMM, AMX, ANK, APB, APC, APR, APS, APZ, AQD, AQF, AOG, AQH, AQJ, ARE, ARJ, ARN, ARS, ART, ARU, ASG, ASJ, ASM, ATQ, ATX, AUW, AUX, AVN, AVP, AWN, AXQ, AYS, AZA, AZB, AZR, BBD, BBG, BCS, BCY, BDV, BEL, BES, BFL, BFM, BGH, BGJ, BGK, BHX, BRV

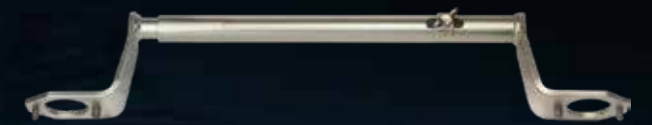

DESCRIPTION	ARTICLE	PRICE EUR*
Camshaft locking tool, Audi/VW	27001L	59,90

CRANKSHAFT LOCKING TOOL, VAG

the camshaft turning tool is used equivalent to OE number T10567 and at the same time replaces OE T40266.

Suitable for the following vehicles:

- ▶ Audi A1 (8X) 2011-; A3 (8V) 2013-; A4 (8K) 2008-; A4 (8W) 2015-; A5 (8T/8F) 2008-; A5 (F5) 2016-; A6 (4G) 2011-; A8 (4H) 2010-; Q2 (GAB) 2016-; Q3 (8U) 2012-; Q5 (8RB) 2008-; Q7 (4MB) 2016-; TT (8J) 2007-; TT (FV) 2015-
- ▶ Seat Alhambra (7N) 2015-; Ibiza (KJ1) 2016-; Leon (5F) 2013-; Ateca (KH7) 2017-
- ▶ Skoda Kodiaq (NS7) 2017-; Octavia III (5E) 2013-; Superb III (3V) 2015-
- ▶ VW Arteon (3H7) 2018-; Beetle (5C) 2012-; Golf VII (5G/BE/BA) 2013-; Jetta IV (16) 2010-; Passat (3G) 2014-; Polo (6R) 2014-; Scirocco (13) 2015-; Sharan (7N) 2016-; Tiguan (AD) 2016-; Touran (5T) 2015-; Transporter (T5) 2010-; Transporter (T6) 2015-

Engine codes:

BPU; BYT; BZB; CABA; CABB; CABD; CADA; CAEA; CAEB; CAED; CAWB; CBFA; CCTA; CCUA; CCZA; CCZC; CDHA; CDHB; CDN; CDNC; CDZA; CESA; CETA; CFKA; CGMA; CHHA; CHHB; CHHC; CHJA; CJEB; CJED; CJEE; CJHA; CJHB; CJKA; CJKB; CJSA; CJSB; CJSC; CJXA; CJXB; CJXC; CJXD; CJXE; CJXF; CJXG; CJXH; CNCB; CNCD; CNCE; CNSB; CNTA; CNTC; CPEA; CPKA; CPLA; CPMA; CPMB; CPPA; CPRA; CPSA; CRHA; CUFA; CUHA; CUHB; CUJA; CULA; CULB; CULC; CVJA; CVKB; CWNA; CWPB; CWZA; CXDA; CXDB; CYFB; CYGA; CYMC; CYNB; CYPA; CYPB; CYRB; CYRC; CYA; CZPA; CZPB; CZRA; DAJA; DAJB; DAXB; DAXC; DAYB; DBFB; DBPA; DBRA; DCAA; DDWA; DEDA; DHGA; DJHA; DJHB; DJHC; DJJA; DLBA; DLRA



DESCRIPTION	ARTICLE	PRICE EUR*
Crankshaft locking tool, VAG	94901L	14,90

ENGINE TIMING TOOL SET, VAG

contains the most important tools for changing the timing belt on 1.2, 1.4 and 1.9 l. VAG TDI engines. for vehicles with round crankshaft sprocket.

Suitable for the following vehicles:

- ▶ Audi A2 '99-'05, A3 '96-'03, A4 '94-'01, A4 '00-'08, A6 '97-'05
- ▶ Ford Galaxy '95-'10
- ▶ Seat Alhambra I '95-'10, Arosa '97-'04, Cordoba '02-'08, Ibiza III '02-'08, Ibiza IV '08-'17, Leon '99-'09, Toledo II '98-'04
- ▶ Škoda Fabia I '99-'07, Fabia II '07-'14, Octavia I '96-'00, Roomster '06-'10, Superb I '01-'08
- ▶ VW Bora I '98-'05, Fox '05-'11, Golf IV '98-'06, Lupo '98-'05, New Beetle '97-'10, Passat IV '96-'05, Polo III '94-'01, Polo IV '01-'09, Sharan I '95-'10

Engine codes: AJM, AMF, ANU, ANY, ARL, ASZ, ATD, ATJ, ATL, AUY, AVB, AVF, AWX, AXR, AYZ, BAY, BEW, BHC, BLT, BMS, BNM, BNV, BSW, BTB, BWB

Used equivalent to the following OE numbers:

- ▶ Locking tool crankshaft, VAG T10050, Ford 310-085
- ▶ Locking pin camshaft/fuel pump, VAG 3359
- ▶ Locking plate tensioner, VAG T10008, Ford 310-084



DESCRIPTION	ARTICLE	PRICE EUR*
Engine timing tool set, VAG	26353L	16,50
Locking plate tensioner	26366L	3,90
Locking pin camshaft/fuel pump	26367L	11,16
Locking tool crankshaft	26368L	11,90

ENGINE TIMING TOOL SET, VAG

contains the most important tools for repair work on 1.9 and 2.0 l. VAG TDI engines. for vehicles with oval crankshaft sprocket.

Suitable for the following vehicles:

- ▶ Audi A4 '00-'08
- ▶ Seat Alhambra '95-'10
- ▶ Škoda Superb '01-'08
- ▶ VW Sharan '95-'10

Engine codes: BKE, BPW, BPZ, BRB, BRC, BSV, BVK

Used equivalent to the following OE numbers:

- ▶ Locking tool crankshaft, VAG T10100
- ▶ Locking pin camshaft/fuel pump, VAG 3359
- ▶ Locking plate tensioner, VAG T10008



DESCRIPTION	ARTICLE	PRICE EUR*
Engine timing tool set, VAG	26356L	16,50
Locking plate tensioner	26366L	3,90
Locking pin camshaft/fuel pump	26367L	11,16
Locking tool crankshaft	26369L	11,90

ENGINE TIMING TOOL SET, VAG

contains the most important tools for repair work on 1.2, 1.5, 1.6, 1.9 and 2.0 l. VAG TDI engines.

Suitable for the following vehicles:

- ▶ Audi A1, A3 (8P), A4 (B8), A5, A6, (C6, C7), TT (8J), Q3, Q5
- ▶ Seat Ibiza (6J), Leon III, Exeo, Toledo, Altea, Alhambra II
- ▶ Škoda Fabia II, Roomster, Praktik, Octavia II, Superb II, Yeti
- ▶ VW Amarok, Beetle II, Caddy II, Eos, Golf V/VI/Plus, Jetta V/VI, Passat B6/B7/CC, Polo V, Scirocco III, Sharan II, Touran II, Tiguan, T5

Engine codes: AVQ, AXB, AXC, AZV, BDJ, BDK, BEE, BGW, BHW, BJB, BKC, BKD, BKP, BLB, BLS, BMA, BMM, BMN, BMP, BMR, BMT, BNA, BPX, BRD, BRE, BRF, BRR, BRS, BRT, BRU, BSS, BST, BSU, BUK, BUY, BUZ, BVA, BVE, BVF, BVG, BVH, BWC, BWV, BXE, BXF, BXJ, CAAA, CAAB, CAAC, CAAD, CAAE, CAGA, CAGB, CAGC, CAHA, CAHB, CAYA, CAYB, CAYC, CAYD, CAYE, CBAA, CBAB, CBAC, CBBA, CBBB, CBDA, CBDDB, CBD, CBEA, CCHA, CCHB, CDBA, CDCA, CEGA, CFCA, CFFA, CFFB, CFFD, CFFE, CFGB, CFGC, CFGD, CFHA, CFHB, CFHC, CFHD, CFHE, CFHF, CFJA, CFJB, CFWA, CGLA, CGLB, CGLC, CGLD, CGLE, CJAA, CJCA, CJC, CJCC, CJCD, CLCA, CLCB, CLJA, CLLA, CLLB, CLNA, CMEA, CMFA, CMFB, CMGA, CMGB, CNEA, CNFA, CNFB, CSHA, CUVB, DDCA, DFSA, DFTB, DFTC

Used equivalent to the following OE numbers:

- ▶ Locking pin camshaft/fuel pump, VAG 3359
- ▶ Locking tool crankshaft, VAG T10050
- ▶ Locking tool crankshaft (oval crankshaft sprocket), VAG T10100
- ▶ Puller camshaft sprocket, VAG T10052
- ▶ Counterholder fuel pump wheel, VAG T10051A
- ▶ Locking tool balance shafts, VAG T10255
- ▶ Locking pin tensioner, VAG T10265
- ▶ Locking pin tensioner V-ribbed belt, VAG T10060A
- ▶ Adjusting tool tensioner, 6 mm, VAG T10264



DESCRIPTION	ARTICLE	PRICE EUR*
Engine timing tool set, VAG	26357L	95,90
Puller camshaft sprocket	26357L-1	28,50
Counterholder fuel pump wheel	26357L-2	49,90
Locking tool balance shafts	26357L-3	9,90
Locking pin tensioner	26357L-4	3,50
Locking pin tensioner V-ribbed belt	26357L-5	1,90
Adjusting tool tensioner, 6 mm	26357L-6	2,40
Locking pin camshaft/fuel pump	26367L	11,16
Locking tool crankshaft	26368L	11,90
Locking tool crankshaft	26369L	11,90

ENGINE TIMING TOOL SET, VAG

contains the most important tools for repair work on 1.6 and 2.0 l. VAG TDI common-rail engines.

Suitable for the following vehicles:

- ▶ Audi A1 '14-'18, A3 '12-'20, A3 '20-, A4 '07-'15, A4 '15-, A5 '07-'16, A5 '16-, A6 '11-'18, A6 '18-, A7 '18-, Q2 '16-, Q3 '11-'18, Q3 '18-, Q5 '08-'17, Q5 '17-, TT '14-'19
- ▶ Cupra formentor '21-
- ▶ MAN TGE '16-
- ▶ Seat Alhambra '10-'22, Arona '17-, Ateca '16-, Ibiza IV '08-'17, Ibiza V '17-, Leon III '12-'20, Leon IV '20-, Tarraco '18-, Toledo IV '12-'19
- ▶ Škoda Fabia III '14-'22, Kamiq '19-, Karoq '17-, Kodiaq '16-, Octavia III '12-'20, Octavia IV '20-, Rapid '12-'19, Scala '19-, Superb III '15-, Yeti '09-'17
- ▶ VW Arteon '17-, Beetle '11-'19, Caddy IV '03-'20, Caddy V '20-, Golf VII '12-'20, Golf VIII '19-, Jetta IV '10-'18, CC '12-'16, Passat VIII '14-'19, Polo V '09-'17, Scirocco '08-'17, Sharan '10-'22, Tiguan I '07-'18, Tiguan II '16-, Touran II '15-, T-Cross '18-, T-Roc '17-, Crafter I '06-'16, Crafter II '16-, Transporter T6 '15-'21, Transporter T7 '21-

Engine codes: CKFB, CKFC, CKTB, CKTC, CKUB, CKUC, CLHA, CLHB, CNHA, CNHC, CRBB, CRBC, CRBD, CRFA, CRFC, CRGB, CRKA, CRKB, CRLB, CRLC, CRLD, CRMB, CRUA, CRVA, CRVC, CSLA, CSLB, CSLC, CSNA, CSUA, CSUB, CSUD, CSUE, CUA, CUNA, CUPA, CUSA, CUSB, CUTA, CUUA, CUUB, CUUD, CUUE, CUUF, CUVA, CUVC, CUVD, CUVE, CUWA, CUXA, CVCA, CXEB, CXEC, CXFA, CXGA, CXGB, CXGD, CXHA, CXHB, CXHC, CXMA, CXXA, CXXB, CYKA, CYKB, CYKC, CYLA, CYZA, CYZB, CZHA, CZJA, DASA, DASB, DASC, DAUA, DAUB, DAVA, DAWA, DBBA, DBGA, DBGB, DBGC, DBKA, DCXA, DCYA, DCYB, DCZA, DDAA, DDCB, DDDA, DDYA, DDYB, DEJA, DEJB, DELA, DESA, DETA, DETB, DEUA, DEUB, DEUC, DEZB, DEZD, DEZE, DEZF, DFBA, DFCA, DFEA, DFEB, DFFA, DFGA, DFGB, DFGC, DFHA, DFLA, DFLD, DFMA, DFSB, DFSC, DFSD, DFSE, DFSF, DFTA, DFUA, DFVA, DGCA, DGDA, DGDB, DGMA, DGTA, DGTC, DGTD, DGTE, DJGA, DLTA, DLTC, DLUB, DMZA, DMZB, DNAA, DNAB, DNAC, DNAD, DNAE, DSRA, DSRB, DSSA, DSTA, DSTB, DSUB, DSUD, DTNA, DTNB, DTPA, DTPB, DTRA, DTRB, DTRC, DTRD, DTRE, DTRF, DTS, DTSB, DTTA, DTTC, DTUA

Used equivalent to the following OE numbers:

- ▶ Fixing tool crankshaft, VAG T10490
- ▶ Counterholder fuel pump wheel, VAG T10051
- ▶ Locking pin tensioner V-ribbed belt, VAG T10060A
- ▶ Adjusting tool tensioner, 6 mm, VAG T10264
- ▶ Locking pin tensioner, VAG T10265
- ▶ 2x Locking pin camshaft/fuel pump, VAG T10492
- ▶ 2x Locking pin camshaft/fuel pump, VAG 3359



DESCRIPTION	ARTICLE	PRICE EUR*
Engine timing tool set, VAG	26365L	118,40
Locking tool crankshaft	26365L-1	59,90
Locking pin camshaft/fuel pump	26365L-2	7,20
Locking pin camshaft/fuel pump	26367L	11,16
Counterholder fuel pump wheel	26357L-2	49,90
Locking pin tensioner	26357L-4	3,50
Locking pin tensioner V-ribbed belt	26357L-5	1,90
Adjusting tool tensioner, 6 mm	26357L-6	2,40

LOCKING TOOL SET, V ENGINES

for locking the crankshaft during work on the engine control, e.g. toothed belt or engine.

Can be used for VW/Audi V6 petrol and V6 + V8 2,5TDI and 3,3TDI diesel engines Audi A8.

Motorcode: AFB, AKE, AKF, AKN, AYM, BAU, BCZ, BFC, BDG, BDH, BND



DESCRIPTION	ARTICLE	PRICE EUR*
Locking tool set, V engines	26086L	11,50

ENGINE ADJUSTMENT TOOL SET, AUDI/VW

contains important tools, e.g. for the following work on VW / Audi 2.7 l and 3.0 l V6 diesel engines.

- ▶ To lock the camshaft and crankshaft
- ▶ To lock the balance shaft
- ▶ To fasten the chain tensioner unit
- ▶ To replace the timing chain
- ▶ To set the timing during engine repairs

Suitable for:

- ▶ VW Touareg, Phaeton
- ▶ Audi A4, A5, A6, A8, Q5, Q7
- ▶ With Motor Codes: ASB, ASE, BKN, BKS, BMC, BMK, BMZ, BNG, BPP, BSG, BTR, BUG, BUN, BVN, CAMA, CAMB, CANA, CANB, CANC, CAND, CAPA, CARA, CARB, CASA, CASB, CASC, CATA, CCF, CCF, CCLA, CCMA, CCWA, CCWB, CDSB, CTEC, CDYA, CDYB, CDYC, CEXA, CGKA, CGKB

Used equivalent to the following OE numbers:

- ▶ Adapter to tension the sprocket T40062
- ▶ Adapter to correct the camshaft setting T40061
- ▶ Swivel adapter for the crankshaft T40049
- ▶ Peg for the injector pump 3359 / T20102
- ▶ Swivel adapter for the crankshaft T40058
- ▶ 2 x camshaft retainers T40060
- ▶ Crankshaft peg 3242



DESCRIPTION	ARTICLE	PRICE EUR*
Engine adjustment tool set, Audi/VW	26132L	119,90
Locking pin crankshaft	26383L-9	9,90
Locking pin camshaft/fuel pump	26367L	11,16

ENGINE ADJUSTMENT TOOL SET, VAG

suitable for 3.0 l TDI V6 diesel engines, used in the following Audi and VW vehicles:

- ▶ Audi A4 (8K), A5 (8F, 8T), A6 (4G), A7 (4G), A8 (4H), Q5 (8R), Q7 (4L)
- ▶ VW Touareg (7P)
- ▶ Engine codes: CDTA, CDTB, CDTG, CDUC, CDUD, CGQB, CJGA, CJGC, CJGD, CKVB, CKVC, CKVD, CLAA, CLAB, CLZB, CMHA, CNRB, CPNA, CPNB, CRCA, CTBA, CTBB, CTBC, CTBD, CTCB, CTCC, CVUA, CVUB, CVUC, DEHA Used equivalent to the following OE numbers:
- ▶ T40257
- ▶ T40314
- ▶ T40060
- ▶ T40062
- ▶ T40061
- ▶ T40049
- ▶ T40245
- ▶ T20102 / 3359
- ▶ T40237 / 3242



DESCRIPTION	ARTICLE	PRICE EUR*
Engine adjustment tool set, VAG	26186L	169,90
Crankshaft turning tool	26186L-1	59,90
Adapter, 1/2"	26186L-2	14,90
Camshaft locking pin	26186L-3	30,50
Camshaft setting tool	26186L-4	52,90
Camshaft turning tool	26186L-5	52,90
Crankshaft turning tool	26186L-6	56,90
Locking pin high pressure pump	26186L-7	10,90

CAMSHAFT POSITIONING AND ASSEMBLY TOOL SET, AUDI/VW

This tool serves for the positioning and installation of the camshafts in the camshaft module. Before the installation of the camshaft module, the positioning and fixing of the camshafts with respect to each other are absolutely necessary. Otherwise the guide bearings in the cylinder head are destroyed and the cylinder head must be renewed.

Necessary in case of diesel engines 1.2/1.5/1.6/2.0/2.7/3.0/4.0/4.2 TDI with 4-valve technology.

Suitable for:

- ▶ Audi A1 (2010-2018), A3 (2003-2015), A4 (2000-2009), A4 (2007-2016), A5 (2007-2017), A6 (2004-2011), A6 (2010-2018), A8 (2002-2010), A8 (2009-2018), Q3 (2011-), Q5 (2008-), Q7 (2006-2016), TT (2006-2015)
- ▶ Seat Alhambra (2010-), Altea (2004-), Exeo (2008-), Ibiza IV (2008-2017), Leon (2005-2013), Toledo III (2004-2009), Toledo IV (2012-2019)
- ▶ Skoda Fabia II (2006-2014), Octavia II (2004-2013), Rapid (2012-), Roomster (2006-2015), Superb II (2008-2015), Yeti (2009-2017)
- ▶ VW Amarok (2010-), Beetle (2011-), Caddy III (2004-2015), Caddy IV (2015-), EOS (2006-2015), Golf VI (2008-2016), Golf Plus (2004-2013), Jetta III (2004-2010), Jetta IV (2008-), Passat (2005-2011), Passat CC (2008-2012), Passat (2010-2015), CC (2011-2016), Phaeton (2002-2016), Polo (2009-), Scirocco (2008-2017), Sharan (2010-), Tiguan (2007-2018), Touareg (2002-2013), Touareg (2010-2018), Crafter (2006-2016), Transporter T5 (2003-2015), Transporter T6 (2015-)

Engine codes:

ASB, ASE, BKN, BKS, BMC, BMK, BNG, BPP, BSG, BTR, BUG, BUN, BVN, CAAA, CAAB, CAAC, CAAD, CAAE, CAGA, CAGB, CAGC, CAHA, CAHB, CAMA, CAMB, CANA, CANB, CANC, CAND, CAPA, CARA, CASA, CASB, CASC, CASD, CATA, CAYA, CAYB, CAYC, CAYD, CAYE, CBAA, CBAB, CBAC, CBBA, CBBB, CBDA, CBDB, CBDC, CBEA, CCFA, CCFC, CCHA, CCHB, CCLA, CCMA, CCWA, CCWB, CDBA, CDCA, CDSB, CDYA, CDYB, CDYC, CEGA, CEXA, CEXB, CFCA, CFFA, CFFB, CFFD, CFFE, CFGB, CFGC, CFGD, CFHA, CFHB, CFHC, CFHD, CFHE, CFHF, CFJA, CFJB, CFWA, CGKA, CGKB, CGLA, CGLB, CGLC, CGLD, CGLE, CJAA, CJCA, CJCB, CJCC, CJCD, CKDA, KCTB, CKTC, CKUB, CKUC, CLCA, CLCB, CLCC, CLCD, CLJA, CLLA, CLLB, CLNA, CMEA, CMFA, CMFB, CMGA, CMGB, CNEA, CNEB, CNFA, CNFB, CSHA, CSLA, CSLB, CSLC, CSNA, CTEC, CWXB, CWXC

Used equivalent to the following OE numbers:

- ▶ T40094
- ▶ T40095
- ▶ T40096

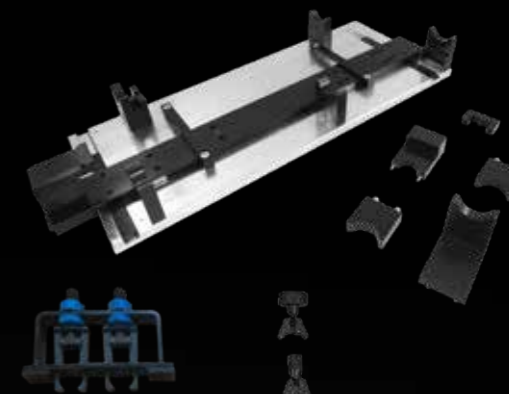

DESCRIPTION	ARTICLE	PRICE EUR*
Camshaft positioning and assembly tool set, Audi/VW	26154L	549,90
Camshaft fixing tool	26154L-1	209,90
Clamping tool camshaft gears	26154L-2	209,50

LOCKING PLATE TENSIONER

for locking the timing belt tensioner on TDI PD engines from Audi, Ford, Seat and VW

Used equivalent to the following OE number:

- ▶ Audi/VW T10008
- ▶ Ford 23-058
- ▶ Ford 310-084



DESCRIPTION	ARTICLE	PRICE EUR*
Locking plate tensioner	26366L	3,90

RETAINING PLATE

for locking the toothed belt clamping jig on TDI pump-injector engines from VW, Audi, Seat and Ford
Applicable like OEM:
▶ T10008



DESCRIPTION	ARTICLE	PRICE EUR*
Retaining plate	26081L	3,50

LOCKING TOOL CRANKSHAFT

for professional locking of the crankshaft in TDC position during timing and engine repairs

Used equivalent to the following OE number:
▶ Ford 23-059
▶ Ford 310-085
▶ Audi/VW T10050



DESCRIPTION	ARTICLE	PRICE EUR*
Locking tool crankshaft	26368L	11,90

LOCKING TOOL CRANKSHAFT

for professional locking of the crankshaft in TDC position during timing and engine repairs

Used equivalent to the following OE number:
▶ Mitsubishi MB-995209
▶ Audi/VW T10100



DESCRIPTION	ARTICLE	PRICE EUR*
Locking tool crankshaft	26369L	11,90

LOCKING PIN CAMSHAFT/FUEL PUMP

for locking the injection pump sprocket on TDI engines without PD as well as for positioning the camshaft on PD engines from Audi, Seat, Škoda, VW and Ford

Used equivalent to the following OE numbers:
▶ Audi/VW 3359
▶ Mitsubishi MB-995206
▶ Seat T20102
▶ Škoda MP1-301
▶ Škoda U40074



DESCRIPTION	ARTICLE	PRICE EUR*
Locking pin camshaft/fuel pump	26367L	11,16

TENSIONER KEY VAG

for VAG



DESCRIPTION	ARTICLE	PRICE EUR*
Tensioner key VAG	10550L	12,90

ADJUSTING TOOL TENSIONER

for professional rotating of the tensioning pulley during timing drive and engine repairs
5-position adjustable and up to 180° rotatable handle. This allows the tool to be used without problems even with tensioners that are difficult to reach.

NEW PRODUCT

Used equivalent to the following OE number:
▶ VAG 3387



DESCRIPTION	ARTICLE	PRICE EUR*
Adjusting tool tensioner	26385L	12,90

TENSIONER KEY VAG

for actuating the automatic tensioning roller when changing the toothed belt on

- ▶ Audi 100 from model year '91, A4, A6 2.5 TDI 5 cyl
- ▶ VW Polo diesel, Lupo from model year '99, LT and T4 2.5 TDI
- ▶ identical engines of other manufacturers (Volvo etc.)



DESCRIPTION	ARTICLE	PRICE EUR*
Tensioner key VAG	10554L	6,90

FLYWHEEL BLOCKING TOOL, VAG

for locking the flywheel during repair work on the clutch or on the timing belt of Seat, Skoda and VW vehicles.

Suitable for the following vehicles:

- ▶ Seat Alhambra (2010-), Altea (2004-), Cordoba (2002-2009), Ibiza III (2002-2009), Ibiza IV (2008-2017), Leon I (1999-2006), Leon II (2005-2013), Toledo II (1998-2006), Toledo III (2004-2009), Toledo IV (2012-)
- ▶ Skoda Fabia II (2006-2014), Superb II (2008-2015)
- ▶ VW Beetle (1998-2011), Beetle (2011-), Bora (1998-2005), Caddy III (2004-2015), CC (2011-2016), Eos (2006-2015), Golf IV (1997-2007), Golf V (2003-2009), Golf VI (2008-2013), Jetta III (2004-2010), Jetta IV (2009-), Lupo (1998-2005), Passat (2005-2011), Passat (2011-2014), Phaeton (2002-2016), Polo (2001-2012), Polo (2009-), Scirocco (2008-2017), Sharan (2010-), Tiguan (2007-2016), Touareg (2002-2015), Touareg (2015-), Touran (2003-2010), Transporter T5 (2003-2015)

Engine codes:

AHT, AQP, ASY, AUE, AXB, AXC, AXJ, AXU, AXZ, AYT, BAG, BDE, BDL, BFH, BHK, BHL, BJS, BKG, BKK, BKL, BLF, BLG, BLN, BLP, BLV, BML, BMY, BRK, BRR, BRS, BTS, BUB, BWK, BWS, CAVA, CAVB, CAVC, CAVD, CAVE, CAVF, CAXA, CAXC, CBRA, CBZA, CBZB, CBZC, CDGA, CDVA, CFNA, CGRA, CKMA, CMSB, CMTA, CNKA, CNNA, CNUB, CNWA, CTHA, CTHB, CTHC, CTHD, CTHE, CTHF, CTJB, CTJC, CTKA

Used equivalent to OE number T10044.



DESCRIPTION	ARTICLE	PRICE EUR*
Flywheel blocking tool, VAG	26309L	51,67

ARRESTER KEY FOR CRANKSHAFT, VAG

for VW 1.4 - 1.6 and 2.0 engines.

- ▶ For arresting the crankshaft belt pulley on 4-valve engines with pin diameter 11.5 mm
- ▶ For arresting the crankshaft toothed belt wheel on 2-valve engines
- ▶ M8 bolt

Suitable for:

- ▶ VW Bora, Caddy, Golf, Lupo, New Beetle, Polo, Sharan, Touran, Transporter
- ▶ Audi A2, A3, A4, A5, TT
- ▶ Skoda Fabia, Octavia, Superb

Engine codes: ADX, AEA, AEE, AEH, AEX, AFH, AFK, AGP, AGR, AHW, AJM, AKL, ALN, AMF, ANA, ANY, APE, APE, APF, ARM, ATJ, AUA, AWH, CGGA, CGPB

Used equivalent to the following OE numbers:

- ▶ T30004
- ▶ 3415



DESCRIPTION	ARTICLE	PRICE EUR*
Arrester key for crankshaft, VAG	10586L	64,90

ARRESTER KEY

for crankshaft belt pulleys, for loosening and tightening the central screw for VW 1.6 l

- ▶ suitable for VW Bora, Golf, Lupo, New Beetle, Polo,
- ▶ Seat Ibiza, Cordoba
- ▶ for engine codes: ARC, ATN, AUS, AVY, AZD, BCB



DESCRIPTION	ARTICLE	PRICE EUR*
Arrester key	10584L	39,90

ENGINE ADJUSTMENT TOOL SET, PORSCHE

contains important tools for the installation and removal of the camshaft, for testing and adjusting the valve timing as well as for timing chain repairs on all Porsche MA1 engines.

Suitable for the following vehicles:

Porsche: 911 type 911 / 911 type 997 / Boxster type 987 / Boxster type 981 / Cayman type 987 / Cayman type 981

Used equivalent to the following OE numbers:

- ▶ Camsaft installation tool equivalent to OE 9772
- ▶ Camshaft holding tool equivalent to OE 9775
- ▶ Crankshaft fixing pin equivalent to OE 9595/1
- ▶ Turning tool for belt pulley equivalent to OE 9773

5-piece



DESCRIPTION	ARTICLE	PRICE EUR*
Engine adjustment tool set, Porsche	26177L	249,95
Camsaft installation tool	26177L-1	479,90
Camshaft holding tool	26177L-2	109,90
Turning tool	26177L-3	42,90
Crankshaft fixing pin	26177L-4	13,90
crankshaft fixing pin	26177L-5	7,90

ENGINE ADJUSTMENT TOOL SET, MERCEDES-BENZ

for locking crankshaft and camshaft on Mercedes-Benz petrol and diesel engines and identical engines in Chrysler PT Cruiser 2.2i CRD, Jeep Grand Cherokee 2.7 CRD etc.

- ▶ Petrol 1.8 / 2.0 / 2.2 / 2.3 / 2.5, M102 und M111
- ▶ Diesel 2.1 / 2.2 / 2.7 / 3.0 / 3.3, OM611, OM612, OM613, OM646

Scope of delivery:

- ▶ Crankshaft locking tool inc. 2 bolts M6x90 / 601589024000
- ▶ Crankshaft locking tool / 602589004000
- ▶ Camshaft locking pins / 111589031500



DESCRIPTION	ARTICLE	PRICE EUR*
Engine adjustment tool set, Mercedes-Benz	26044L	79,90

ENGINE TIMING TOOL SET, MERCEDES-BENZ

contains the most important tools for repair work on 1.6 and 1.8 l Mercedes-Benz petrol engines.

Suitable for the following vehicles:

Mercedes-Benz: C-Klasse '00-'07, C-Klasse '07-'15, CLK '03-'10, E-Klasse '02-'09, E-Klasse '09-'17, SLK '04-'11, SLK '11-'20 und Sprinter '06-'18

Engine codes: M271.820, M271.860, M271.861, M271.910, M271.911, M271.921, M271.940, M271.941, M271.942, M271.944, M271.946, M271.948, M271.950, M271.951, M271.952, M271.954, M271.955, M271.956, M271.957, M271.958

Used equivalent to the following OE numbers:

- ▶ Retainer timing chain, Mercedes 271.589.01.40.00
- ▶ Locking tool camshafts, Mercedes 271.589.00.61.00
- ▶ Locking tool chain tensioner, Mercedes 271.589.00.15.00
- ▶ Wedge slide rails, Mercedes 271.589.00.31.00



DESCRIPTION	ARTICLE	PRICE EUR*
Engine timing tool set, Mercedes-Benz	26364L	247,90
Retainer timing chain	26364L-1	89,90
Locking tool camshafts	26364L-2	76,10
Locking tool chain tensioner	26364L-3	18,30
Wedge slide rails	26364L-4	49,90
Screwdriver bit, T100 x 75 mm, 1/2"	05389L	14,60

ENGINE ADJUSTMENT TOOL SET, MERCEDES-BENZ

for Mercedes-Benz 1.6l/ 2.0l direct-injection petrol engines with engine code M270 and M274 from '11 to set the engine timing during replacement of the timing chain or repair of the engine.

Suitable for:
Mercedes-Benz A Class (176) / B Class (242, 246) / C Class (204, 205) / CLA (117) / E Class (207, 212) / GLA (156) / SLK (172) / Infiniti Q50

Used equivalent to Mercedes-Benz OE number:
▶ Camshaft locking device 270 589 00 61 00

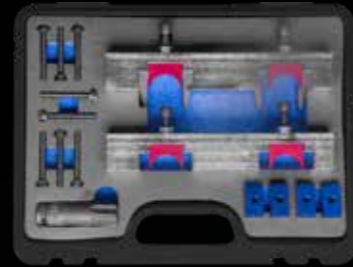

DESCRIPTION	ARTICLE	PRICE EUR*
Engine adjustment tool set, Mercedes-Benz	26165L	319,90
Camshaft clamping assembly for chain end	26165L-1	342,90
Camshaft clamping assembly for gearbox end	26165L-2	197,90
Camshaft block with small diameter	26165L-3	21,90
Hexagon head screw M7 x 50	26165L-4	2,70
Screwdriver bit, T100 x 75 mm, 1/2"	05389L	14,60

ENGINE ADJUSTMENT TOOL SET, MERCEDES-BENZ

for 1.8l / 2.2l four-cylinder Mercedes-Benz Diesel engines from '08 with timing chain and engine code OM 651. Contains two camshaft locking devices and one crankshaft belt pulley locking device. For setting the engine timing e.g. during replacement of the timing chain or during engine repairs.

Suitable for:
A180 / A200 / A220 CDI / Blue Efficiency (W176), B180 / B200 / B220 CDI / Blue Efficiency (W246), C180 / C200 / C220 CDI / Blue Efficiency (W/S/C 204), CLA200 / CLA220 (C117), E200 CDI / Blue Efficiency / BlueTec (W/S 212), GLA200 / GLA220 CDI (X156), GLK200 CDI Blue Efficiency (X204), Sprinter 210 / 213 / 216 / 310 / 313 / 316 / 413 / 416 / 510 / 513 / 516 CDI / BlueTec (W906), Vito110 / 113 / 116, Viano 2.0 / 2.2 CDI (W/V639), Vito 114 / T16 CDI, V200 / V220 CDI (W/V447)

Used equivalent to the following Mercedes-Benz OE numbers:
▶ 651 589 09 4000 camshaft locking device
▶ 651 589 00 4000 crankshaft belt pulley locking device



DESCRIPTION	ARTICLE	PRICE EUR*
Engine adjustment tool set, Mercedes-Benz	26185L	139,90
Camshaft locking tool kit for Mercedes M651	26185L-2	94,50
Crankshaft belt pulley locking device	26164L-2	21,50

TIMING CHAIN TOOL, MERCEDES-BENZ

special tool for separating and riveting the timing chains of gasoline and diesel engines with single and double timing chain on Mercedes-Benz vehicles.

Used equivalent to the following OE numbers:

- ▶ 703 589 016 300
- ▶ 112 589 046 301
- ▶ 112 589 069 300
- ▶ 602 589 003 900
- ▶ 602 589 023 300
- ▶ 602 589 024 000
- ▶ 602 589 026 300
- ▶ 602 589 036 300
- ▶ 602 589 046 300



DESCRIPTION	ARTICLE	PRICE EUR*
Timing chain tool, Mercedes-Benz	26310L	249,90

ENGINE ADJUSTMENT TOOL SET, BMW

Contains important tools e.g. for the following tasks on petrol engines M40, M43 as well as engines with double camshafts M42, M44, M50, M52, M54, M56:

- ▶ Installing and removing as well as adjusting the camshaft unit
- ▶ Checking and setting the camshaft timing
- ▶ Changing the toothed belt on the M40 engine



DESCRIPTION	ARTICLE	PRICE EUR*
Engine adjustment tool set, BMW	26103L	169,90

ENGINE ADJUSTMENT TOOL SET, BMW

Includes important tools, e.g. for the following work on diesel engines M41, M47, M51, M57:

- ▶ Installation and removal of the camshafts
- ▶ Installation and removal of the hydraulic chain tensioner
- ▶ Testing and adjusting the camshaft timing



DESCRIPTION	ARTICLE	PRICE EUR*
Engine adjustment tool set, BMW	26104L	199,90

TIMING CHAIN TESTING TOOL, BMW / MINI

allows testing of the chain elongation on BMW and Mini petrol engines with 1.4 and 1.6 l capacity as well as diesel engines with 1.6 and 2.0 l capacity. The test is carried out by replacing the installed chain tensioner with this tool. A possible elongation is directly readable.

Suitable for the following vehicles:

- ▶ Alpine D3 E90 / E91 / E92
- ▶ BMW series 1 E81 / E82 / E87 / E88 / F20 / F21
- ▶ BMW series 2 F22 / F87
- ▶ BMW series 3 E90 / E91 / E92 / E93 / F30 / F31 / F34 / F35 / F80
- ▶ BMW series 4 F32 / F33 / F36 / F82 / F83
- ▶ BMW series 5 E60 / E61 / F07 / F10 / F11
- ▶ BMW series X1 E84
- ▶ BMW series X3 E83 / F25
- ▶ BMW series X5 F15 / F85
- ▶ Mini R55 Clubman
- ▶ Mini R56
- ▶ Mini R57 Cabriolet
- ▶ Mini R58 Coupe
- ▶ Mini R59 Roadster
- ▶ Mini R60 Countryman
- ▶ Mini R61 Paceman

Engine codes: N12, N13, N14, N16, N18, N47

Used equivalent to OE number 2.353.281.

Die beiliegende Distanzscheibe ist nur für Messungen an N14 Motoren zu verwenden!



DESCRIPTION	ARTICLE	PRICE EUR*
Timing chain testing tool, BMW / Mini	26311L	29,90

ENGINE ADJUSTMENT TOOL SET

contains important tools for working on 1.6l petrol engines with the engine code N40, N45 e.g.

- ▶ for installing and removing the camshafts
- ▶ for checking and setting the camshaft timing
- ▶ for replacing the timing chain
- ▶ for replacing the cylinder head gasket
- ▶ for setting the Vanos adjustment unit
- ▶ for pre-tensioning the chain tensioner

Suitable for:

- ▶ BMW 116i (E81 / E87) engine code: N45, model years: '04-'10, 316i/316ti (E46) engine code: N40, model years: '02-'05, 316i (E90) engine code: N45, model years: '07-'09

Comparable to:

- ▶ camshaft fixing kit BMW OE no. 11 7 250 (11 7 251 inlet camshaft, 11 7 252 outlet camshaft, 11 7 253 screw)
- ▶ chain tensioner pre-tension BMW OE no. 11 9 340
- ▶ camshaft sensing wheels fixing kit BMW OE no. 11 7 260
- ▶ crankshaft peg BMW OE no. 11 9 190

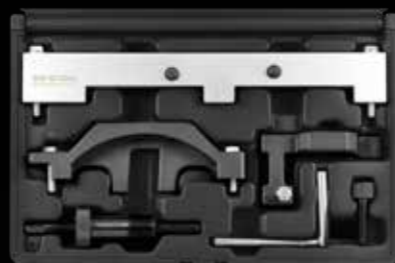

DESCRIPTION	ARTICLE	PRICE EUR*
Engine adjustment tool set	26112L	199,90
Locking tool flywheel	26378L-5	9,90

ENGINE ADJUSTMENT TOOL SET, BMW

contains important tools e.g. for the following tasks on 4 cylinders petrol engines N42, N46 and N46T.

- ▶ Installing and removing the camshafts and the variable camshaft unit (double variable camshaft phasing)
- ▶ Checking and setting the camshaft timing

Suitable for:

BMW 1-series E81/E87, 3-series E46, E90,E91, X3 E83, Z4 E85, 5er E60, E61



DESCRIPTION	ARTICLE	PRICE EUR*
Engine adjustment tool set, BMW	26105L	359,90
Engine adjustment tool BMW	26105L-12	54,90
Engine adjustment tool BMW	26105L-13	55,90
Engine adjustment tool BMW	26105L-14	80,90
Locking tool flywheel	26378L-5	9,90

ENGINE TIMING TOOL SET, BMW

for locking the camshaft and crankshaft on 1.6, 1.8 and 2.0 BMW N43 engines.

Installed in the following vehicles:

- ▶ BMW 1er (E81/82/87/88) '04-'13
- ▶ BMW 3er (E90/91/92/93) '05-'13
- ▶ BMW 5er (E60/61) '03-'10

Used equivalent to the following OE numbers::

- ▶ Timing chain pre-tensioning tool, BMW 11.9.340
- ▶ Locking tool chain tensioner, BMW 11.3.340
- ▶ Adjustment tool pulse generator, BMW 11.8.710
- ▶ Locking tool camshafts, BMW 11.8.690
- ▶ Adjustment tool balance shafts, BMW 11.8.700
- ▶ Locking tool flywheel, BMW 11.5.120



NEW
PRODUCT

DESCRIPTION	ARTICLE	PRICE EUR*
Engine timing tool set, BMW	26378L	189,90

ENGINE TIMING TOOL SET, BMW

DESCRIPTION	ARTICLE	PRICE EUR*
Pretensioning tool timing chain	26374L-5	13,90
Locking tool chain tensioner	26378L-1	3,90
Adjustment tool pulse generator	26378L-2	99,90
Locking tool camshafts	26378L-3	89,90
Adjustment tool balance shafts	26378L-4	14,90
Locking tool flywheel	26378L-5	9,90

ENGINE ADJUSTMENT TOOL SET

contains important tools e.g. for doing the following tasks on 1.6l / 1.8l / 2.0L petrol engines with the engine code N43

- ▶ for installing and removing the camshafts
- ▶ for checking and setting the camshaft timing
- ▶ for replacing the timing chain
- ▶ for replacing the cylinder head gasket
- ▶ for setting the Vanos adjustment unit
- ▶ for pre-tensioning the chain tensioner
- ▶ for aligning the balancer shafts

Suitable for BMW:

- ▶ 116i / 118i / 120i (E81, E87, E88) engine code: N43 from model year '07
- ▶ 316i / 318i / 320i (E90, E92, E93) engine code: N43 from model year '07
- ▶ 520i (E60, E61) engine code: N43 from model year '06

Applicable like:

- ▶ camshaft fixing kit BMW OE no. 11 8 690
- ▶ chain tensioner pre-tension BMW OE no. 11 9 340
- ▶ crankshaft peg BMW OE no. 11 5 120
- ▶ camshaft sensing wheels fixing kit BMW OE no. 11 8 710
- ▶ locking pins oil pump BMW OE no. 2 x 11 3 340
- ▶ locking gauge balancer shafts BMW OE no. 11 8 700



DESCRIPTION	ARTICLE	PRICE EUR*
Engine adjustment tool set	26114L	199,90
Retainer for balance shafts	26114L-4	32,50
Peg	26105L-16	12,80

ENGINE TIMING TOOL SET, BMW

for locking the camshaft and crankshaft on 1.6, 2.0 and 3.0 BMW diesel engines

**NEW
PRODUCT**

Installed in the following vehicles:

- ▶ BMW 1er (E81/82/87/88) '04-'13, 1er (F20/21) '11-'19
- ▶ BMW 2er (F22/23/87) '13-'21
- ▶ BMW 3er (E90/91/92/93) '05-'13, 3er (F30/31/34/35) '11-'19
- ▶ BMW 4er (F32/33/36) '13-'21
- ▶ BMW 5er (E60/61) '03-'10, 5er (F10/11/18) '10-'17
- ▶ BMW 6er (F12/13/06) '11-'18
- ▶ BMW 7er (F01/02/03/04) '08-'15
- ▶ BMW X1 (E84) '09-'15
- ▶ BMW X3 (E83) '03-'10, X3 (F25) '10-'17
- ▶ BMW X4 (F26) '14-'18
- ▶ BMW X5 (E70) '06-'13, X5 (F15/85) '13-'18
- ▶ BMW X6 (E71/72) '08-'14, X6 (F16/86) '14-'19
- ▶ Mini (R55/56/57/58/59/60/61) '06-'16

Engine codes: N47, N57

Used equivalent to the following OE numbers::

- ▶ Locking tool chain tensioner, BMW 11.3.340
- ▶ Locking tool flywheel, BMW 11.5.320
- ▶ Locking tool camshaft, BMW 11.8.760
- ▶ Sprocket puller fuel pump, BMW 11.8.030
- ▶ Crankshaft turning tool, BMW 11.6.480
- ▶ Crankshaft retaining tool, BMW 11.4.320
- ▶ Locking tool flywheel, BMW 11.9.260



DESCRIPTION	ARTICLE	PRICE EUR*
Engine timing tool set, BMW	26379L	134,90
Locking tool chain tensioner	26378L-1	3,90
Locking tool flywheel	26379L-1	12,90
Locking tool camshaft	26379L-2	24,90
Chain wheel puller fuel pump, BMW	26370L	15,90
Turning tool crankshaft	26379L-3	19,90
Special adapter for 10mm screwdriver bits	05600L	5,00
Locking tool crankshaft	26379L-4	24,90
Locking tool flywheel, BMW/Mini	26380L	34,90

CHAIN WHEEL PULLER FUEL PUMP, BMW

for pulling off the sprocket when removing the high-pressure fuel pump on BMW engines

Suitable for the following vehicles:

- ▶ BMW 116d, 118d, 120d, 123d (E81, E82, E87, E88, F20) / 316d, 318d, 320d, 325d, 330d (E90, E91, E92, E93, F30) / 520d, 525d, 530d, 530d GT, 535d, 535d GT, M550d (E60, E61, F07, F10, F11) / 640d (F12) / 730d, 740d, 750d (F01) / X1-1.8d, 2.0d, 2.3d (E84) / X3-1.8d, 2.0d, 3.0d, 3.5d (E83, F25) / X5-3.0d, 4.0d, M5.0d (E70) / X6-3.0d, 4.0d, M5.0d (E71)

Engine codes: N47, N47S, N57, N57S

Used equivalent to the following OE numbers:

- ▶ Puller, OE number 11.8.740
- ▶ Puller sleeve, OE number 11.8.741
- ▶ Hexagon adapter, OE number 11.8.742



DESCRIPTION	ARTICLE	PRICE EUR*
Chain wheel puller fuel pump, BMW	26370L	15,90

ENGINE ADJUSTMENT TOOL SET, BMW

suitable for operations on BMW 2.5 l and 3.0 l, 6-cylinder petrol engines with double camshaft, installed in the following vehicles:

- ▶ Alpine B3 E90 / E91 / E92 / E93 / F30 / F31
- ▶ Alpine B4 F32 / F33
- ▶ BMW 1 Series E81 / E82 / E87 / E88 / F20 / F21
- ▶ BMW 2 Series F22 / F23 / F87
- ▶ BMW 3 Series E90 / E91 / E92 / E93 / F30 / F31 / F34 / F35 / F80
- ▶ BMW 4 Series F32 / F33 / F36 / F82 / F83
- ▶ BMW 5 Series E60 / E61 / F07 / F10 / F11 / F18
- ▶ BMW 6 Series E63 / E64 / F06 / F12 / F13
- ▶ BMW 7 Series E65 / E66 / E67 / F01 / F02 / F03 / F04
- ▶ BMW X1 series E84
- ▶ BMW X3 series E83 / F25
- ▶ BMW X4 series F26
- ▶ BMW X5 series E70 / F15 / F85
- ▶ BMW X6 series E71 / E72 / F16 / F86
- ▶ BMW Z4 series E85 / E86 / E89
- ▶ Morgan EVA GT

Engine codes: N51 / N52 / N52K / N53 / N54 / N55

Used equivalent to the following OE numbers:

- ▶ 11.0.300
- ▶ 11.4.280
- ▶ 11.4.281
- ▶ 11.4.282
- ▶ 11.4.283
- ▶ 11.4.285
- ▶ 11.4.290
- ▶ 11.8.520
- ▶ 11.9.340



DESCRIPTION	ARTICLE	PRICE EUR*
Engine adjustment tool set, BMW	26307L	419,90

ENGINE ADJUSTMENT TOOL SET, BMW/MINI

for a professional engine repair at 1.5 and 2.0 l BMW diesel engines B37 and B47, installed in the following vehicles:

BMW:

- ▶ 1 (F20/F21)
- ▶ 2 (F22/F23/F45/F46/F87)
- ▶ 3 (F30/F31/F34/F80)
- ▶ 4 (F32/F33/F36/F82/F83)
- ▶ 5 (F10/F11/F90/G30/G31)
- ▶ 6 (G32)
- ▶ 7 (G11/G12)
- ▶ X1 (F48)
- ▶ X2 (F39)
- ▶ X3 (F25/G01)
- ▶ X4 (F26/G02)
- ▶ X5 (F15/F85)

Mini:

- ▶ Mini (F55/F56/F57)
- ▶ Clubman (F54)
- ▶ Countryman (F60)

Used equivalent to the following OE numbers:

- ▶ 11 4 120
- ▶ 11 4 180
- ▶ 11 6 480
- ▶ 11 8 030
- ▶ 11 8 760
- ▶ 11 9 264
- ▶ 11 9 265
- ▶ 2 288 380
- ▶ 2 357 904
- ▶ 2 365 488



DESCRIPTION	ARTICLE	PRICE EUR*
Engine adjustment tool set, BMW/Mini	26191L	119,90
Chain wheel puller fuel pump, BMW	26370L	15,90

TENON WRENCH, BMW / MINI

serves as a release key for the camshaft adjusters on the BMW / Mini B38, B46 and B48 vehicles.
Used equivalent to OE number: 2.360.895.



DESCRIPTION	ARTICLE	PRICE EUR*
Tenon wrench, BMW / Mini	10567L	21,90

SPECIAL SOCKET, 1/2"

for operations on the central valve of the camshaft adjuster on BMW and Mini.

Motor codes: B36A, B38A, B38B, B46A, B48A, B48B, B58B

Suitable for the following vehicles:

- BMW:**
- ▶ 1 F20 / F21
 - ▶ 2 F22 / F23 / F45 / F46 / F87
 - ▶ 3 F30 / F31 / F34 / F80
 - ▶ 4 F32 / F33 / F36 / F82 / F83
 - ▶ 5 F90 / G30 / G31
 - ▶ 6 G32
 - ▶ 7 G11 / G12
 - ▶ X1 F48
 - ▶ X2 F39
 - ▶ X3 G01
 - ▶ X4 G02

Mini F54 / F55 / F56 / F57 / F60

Used equivalent to BMW OE number 2450487.



DESCRIPTION	ARTICLE	PRICE EUR*
Special socket, 1/2"	04466L	6,20

CRANKSHAFT HOLDING TOOL

For positioning the crankshaft when replacing the timing chain.

Suitable for N47 and N57 engines:

- ▶ X1 (E84)
- ▶ X3 (E83, F25)
- ▶ X4 (F26)
- ▶ X5 (E70, F15)
- ▶ X6 (E71, F16)
- ▶ Series 1 (E81 / 82/87/88, F20 / 21)
- ▶ Series 2 (F22)
- ▶ Series 3 (E90 / 91/92/93, F30 / 31/34)
- ▶ Series 4 (F32 / 33/36)
- ▶ Series 6 (F12 / 13, F06)
- ▶ Series 7 (F01 / 02/04)

Can be used like BMW OE no.114320



DESCRIPTION	ARTICLE	PRICE EUR*
Crankshaft Holding Tool	26167L	24,90

LOCKING TOOL FLYWHEEL, BMW/MINI

for locking the flywheel during repair work on the timing drive

Engine codes: M47TU, M54, M57T2, M57TU, N40, N42, N43, N45, N45T, N46, N46T, N51, N52, N53, N54, N62, N73, S85, W17

Used equivalent to the following OE number:

- ▶ BMW 11.9.260



NEW
PRODUCT

DESCRIPTION	ARTICLE	PRICE EUR*
Locking tool flywheel, BMW/Mini	26380L	34,90

REMOVAL AND ASSEMBLY SET RETURN SPRING, CITROËN / MINI / PEUGEOT

Special tool for assembling and disassembling the return spring on the intermediate lever on Citroën, Mini, Peugeot vehicles with variable valve timing.

Suitable for the following vehicles:

- ▶ Citroën: Berlingo, C3 II, C3 Picasso, C4 I, C4 II, C4 Picasso, C5 III, DS3, DS4, DS5
- ▶ Mini: Clubman (R55), Countryman (R60), Mini (R56 / R57 / R58 / R59), Paceman (R61)
- ▶ Peugeot: 207, 208, 2008, 308, 3008, 408, 508, 5008, RCZ, Partner Tepee

Engine Codes:

- ▶ Mini N12, N16, N18
- ▶ Citroën / Peugeot: EP3, EP3C, EP6, EP6C

Used equivalent to the following OE numbers:

- ▶ 119570
- ▶ 119571
- ▶ 119572
- ▶ 0197.3B

2-piece



DESCRIPTION	ARTICLE	PRICE EUR*
Removal and assembly set return spring, Citroën / Mini / Peugeot	26302L	259,90

SLIDING BLOCK FIXING TOOL, BMW / MINI

Special pliers for fixing and aligning the sliding blocks on the eccentric shaft of BMW / Citroën / Mini / Peugeot vehicles with variable valve timing.

Suitable for the following vehicles:

- ▶ BMW: 1 (F20 / F21), 3 (F30 / F31 / F35 / F80)
- ▶ Citroën: Berlingo, C3 II, C3 Picasso, C4 I, C4 II, C4 Picasso, C5 III, DS3, DS4, DS5
- ▶ Mini: Clubman (R55), Countryman (R60), Mini (R56 / R57 / R58 / R59), Paceman (R61)
- ▶ Peugeot: 207, 208, 2008, 308, 3008, 408, 508, 5008, RCZ, Partner Tepee

Engine Codes:

- ▶ BMW N13
- ▶ Mini N12, N16, N18
- ▶ Citroën / Peugeot: EP3, EP3C, EP6, EP6C

Used equivalent to the following OE numbers:

- ▶ 119573
- ▶ 0197.3C



DESCRIPTION	ARTICLE	PRICE EUR*
Sliding block fixing tool, BMW / Mini	26301L	99,90

REMOVAL AND ASSEMBLY SET RETURN SPRING, BMW

for assembly and disassembly of intermediate lever compression springs on BMW vehicles with variable valve timing.

Suitable for the following BMW vehicles:

- ▶ 1 (E81 / E82 / E87 / E88)
- ▶ 1 (F20 / F21)
- ▶ 2 (F22 / F23 / F87)
- ▶ 3 (E90 / E91 / E92 / 93)
- ▶ 3 (F30 / F31 / F34 / F80)
- ▶ 4 (F32 / F33 / F36 / F83 / F82)
- ▶ 5 (E60 / E61)
- ▶ 5 (F07 / F10 / F11)
- ▶ 6 (E63 / E64)
- ▶ 6 (F06 / F12 / F13)
- ▶ 7 (E65 / E66 / E67)
- ▶ 7 (F01 / F02 / F03 / F04)
- ▶ X1 (E84)
- ▶ X3 (E83)
- ▶ X3 (F25)
- ▶ X4 (F26)
- ▶ X5 (E70)
- ▶ X5 (F15 / F86)
- ▶ X6 (F16 / F86)
- ▶ Z4 (E85 / E86 / E89)

Engine codes: N13, N20, N26, N52, N55
Used equivalent to OE number 117110.



DESCRIPTION	ARTICLE	PRICE EUR*
Removal and assembly set return spring, BMW	26195L	223,90

SLIDING BLOCK FIXING TOOL, BMW

Special tool for fixing and aligning the sliding blocks on the eccentric shaft of BMW vehicles with variable valve timing.

Suitable for the following BMW vehicles:

- ▶ 1 (E81 / E82 / E87 / E88)
- ▶ 1 (F20 / F21)
- ▶ 2 (F22 / F23 / F87)
- ▶ 3 (E90 / E91 / E92 / 93)
- ▶ 3 (F30 / F31 / F34 / F80)
- ▶ 4 (F32 / F33 / F36 / F83 / F82)
- ▶ 5 (E60 / E61)
- ▶ 5 (F07 / F10 / F11)
- ▶ 6 (E63 / E64)
- ▶ 6 (F06 / F12 / F13)
- ▶ 7 (E65 / E66 / E67)
- ▶ 7 (F01 / F02 / F03 / F04)
- ▶ X1 (E84)
- ▶ X3 (E83)
- ▶ X3 (F25)
- ▶ X4 (F26)
- ▶ X5 (E70)
- ▶ X5 (F15 / F86)
- ▶ X6 (F16 / F86)
- ▶ Z4 (E85 / E86 / E89)

Engine codes: N20, N26, N52, N55
Used equivalent to OE number 114450.



DESCRIPTION	ARTICLE	PRICE EUR*
Sliding block fixing tool, BMW	26304L	79,90

CRANKSHAFT ARRESTER, BMW/MINI/PEUGEOT

for loosening and tightening the crankshaft central screw.

Suitable for:

- ▶ BMW / Mini: N12, N14, N18, N40, N42, N43, N45, N46, N51, N52, N53, N63
- ▶ Peugeot: EP3, EP6, EP6DT, EP6DTS

Used equivalent to the following OE-number:

- ▶ BMW OE-No. 119280



DESCRIPTION	ARTICLE	PRICE EUR*
Crankshaft arrester, BMW/Mini/Peugeot	10589L	57,90

FLYWHEEL HOLDER, BMW/MINI

for blocking the flywheel when releasing and tightening the central screws on the vibration absorber (crankshaft belt pulley) in diesel and petrol engines with the following engine codes:

- ▶ M47T2 / M47TU / M57T2 / M57TU / M67 / N43 / N45 / N45T / N46 / N46T / N47 / N47S / N51 / N52 / N53 / N54 / W17

For the following work, e.g. when:

- ▶ Exchanging the vibration absorber
- ▶ Replacing the crank shaft radial seal ring (on the front)

Suitable for:

- ▶ 116i, 118i, 120i, 128i, 130i, 135i, 135is, 118d, 120d, 123d (E81, E82, E87, E88) / 316i, 318i, 318ti, 320i, 320Si, 323i, 325i, 325xi, 328i, 328xi, 330i, 330xi, 335i, 335xi, 318d, 320d, 320td, 325d, 330d, 330xd, 335d (E46, E90, E91, E92, E93) / 520i, 523i, 525i, 525xi, 530i, 530xi, 535i, 535xi, 520d, 525d, 525xd, 530d, 530xd, 535d, (E60, E61) / 630i, 635d (E63, E64) / 730i, 730d, 740d, (E38, E65, E66) / X3-2.0i, X3-2.0d, X3-3.0d, X5-3.0D, X6-3.5D, X6-3.0d, X6-3.5d (E53, E70, E83) / Z4-2.0i, Z4-2.5i, Z4-3.0i (E85, E86) / Mini One, (R50)

Used equivalent to the following OE numbers:

- ▶ Counter support (complete) 11 8 180
- ▶ Connecting holder 11 8 182
- ▶ Base plate 11 8 183
- ▶ Adaptor (for E65/M67) 11 8 184
- ▶ Adaptor with an adjusting sleeve (for E46/M47TU) 11 8 185



DESCRIPTION	ARTICLE	PRICE EUR*
Flywheel holder, BMW/Mini	10588L	99,90

BALANCE SHAFT FIXATION, BMW N40-N46

Fixing gauge for adjusting the balancer shafts in the oil pump unit.

Opening: 6 mm

Suitable for:

- ▶ BMW models with engine code N40, N42, N45, N46

Used equivalent to the following OE-number:

- ▶ BMW OE-No. 119330



DESCRIPTION	ARTICLE	PRICE EUR*
Balance shaft fixation, BMW N40-N46	26143L	14,90

FIXING GAUGE FOR ADJUSTING THE OIL PUMP UNIT'S BALANCER SHAFTS

Fixing gauge for adjusting the oil pump unit's balancer shafts (new version).
Suitable for BMW models with engine codes: N45, N46.
Applicable like: BMW OE no. 115140.



DESCRIPTION	ARTICLE	PRICE EUR*
Fixing gauge for adjusting the oil pump unit's balancer shafts	26144L	14,90

TIMING BELT INSPECTION TOOL, CITROËN/OPEL/PEUGEOT/TOYOTA

Some engines use timing belts that run in an oil bath. Ageing or using the wrong engine oils can change the structure of the timing belt, increasing its width. With this inspection tool, the width of the timing belt can be checked quickly and easily. This check must be carried out during all maintenance work (every 12 months or 20,000 km). To do this, remove the oil filler cap and measure the width of the timing belt.

Suitable for:

- ▶ Citroën Berlingo, C1 II, C3 II/III, C4 II, C5 X, C-Elysee, DS3 and DS4
- ▶ Opel Astra L, Crossland X, Grandland X, Mokka
- ▶ Peugeot 108, 208 I/II, 2008 I/II, 308 II/III, 3008, 508 II, 5008, Partner Tepee, Rifter
- ▶ Toyota Aygo II

Engine codes: 1PP, B12XE, B12XHL, B12XHT, D12XE, D12XHL, D12XHT, F12XE, F12XHL, F12XHT, EBO, EB2, EB2ADT, EB2ADTD, EB2ADTS, EB2D, EB2DT, EB2DTM, EB2DTS, EB2DTS, EB2F, EB2FA, EB2FB, EB2FD, EB2M, HMP, HMR, HMT, HMU, HMY, HMZ, HNK, HNP, HNS, HNV, HNX, HNY, HNZ, ZMZ

Used equivalent to the following OE numbers:

- ▶ Opel EN-52809
- ▶ PSA 0109.6
- ▶ Toyota 16431-90080



**NEW
PRODUCT**

DESCRIPTION	ARTICLE	PRICE EUR*
Timing belt inspection tool, Citroën/Opel/Peugeot/Toyota	26324L	12,90

ENGINE ADJUSTMENT TOOL SET, OPEL

Contains important tools e.g. for the following work:

- ▶ Locking the flywheel
- ▶ Locking the crankshaft
- ▶ Locking the camshaft
- ▶ Locking the injection pump shaft
- ▶ Pulling off the crankshaft belt pulley
- ▶ Tensioning the toothed belt

Used equivalent to the following OE numbers:

- ▶ KM852
- ▶ KM853
- ▶ KM-933
- ▶ KM-933
- ▶ KM-927
- ▶ KM-929
- ▶ KM-952
- ▶ KM-954
- ▶ KM 955
- ▶ KM953
- ▶ KM6148
- ▶ KM 6077
- ▶ KM 6148 / KM6077
- ▶ KM6130
- ▶ KM911
- ▶ EN-46788/1 860 905 000
- ▶ EN-46788 / 1 860 905 000
- ▶ EN-46788/1 860 905 000
- ▶ EN-46788 / 1 860 905 000
- ▶ EN-46781
- ▶ EN-46785
- ▶ EN-46781

Die Nockenwellen- und Kurbelwellenarretierungen dürfen nicht als Gegenhalter zum Anziehen genutzt werden!



DESCRIPTION	ARTICLE	PRICE EUR*
Engine adjustment tool set, Opel	26053L	319,90
Water pump locking tool, 26053L	26053L-1	98,90
Camshaft locking tool	26053L-2	29,50
Camshaft locking tool	26053L-3	35,90
Setting gauge pulse encoder disc	26350L-3	19,90
Crankshaft locking mechanism	26053L-8	21,50
Locking pin for the timing chain tensioning unit	26053L-10	3,90
Locking pins for the camshaft sprocket	26053L-12	37,50
Locking tool camshafts	26323L-3	39,90
Camshaft setting tool (Opel)	26053L-14	45,90
Adjusting tool camshafts	26350L-1	12,90
Locking pin crankshaft	26350L-2	16,90
Crankshaft locking pin (Opel)	26053L-18	7,90
Add-on to the crankshaft locking mechanism	26053L-19	8,50
Injection pump locking mechanism (Opel)	26053L-20	6,50
Locking pin tensioner V-ribbed belt	26363L-5	8,50
Tensioner locking mechanism	26053L-21	4,90
Locking pin chain tensioner, ø 4,0 mm	26350L-5	5,50

ENGINE TIMING TOOL SET, OPEL

for locking the camshafts and crankshaft on 3 cylinder 1.0 turbo SIDI petrol engines.

Installed in the following vehicles:

- ▶ Opel Adam '12-'19, Astra K '15-'22, Corsa E '14-'19

Engine codes: B10XFL, B10XFT, B10XHL, D10XFL, D10XFT, F10XFL, F10XFT

Used equivalent to the following OE numbers:

- ▶ Balance shaft retaining tool, Opel EN-51298
- ▶ Locking tool camshafts, Opel EN-51367



DESCRIPTION	ARTICLE	PRICE EUR*
Engine timing tool set, Opel	26315L	59,90
Balancer shaft retaining tool	26315L-1	39,90
Adjusting tool camshafts	26315L-2	29,70

ENGINE TIMING TOOL SET, OPEL

contains the most important tools for repair work on 1.0, 1.2 and 1.4 l. Opel engines with double camshaft

Suitable for the following vehicles:

- ▶ Nissan Pixo '09-'13
- ▶ Opel Agila A '00-'07, Astra G '98-'09, Astra H '04-'09, Combo C '01-'11, Corsa B '93-'00, Corsa C '00-'06, Corsa D '06-'14, Meriva A '03-'10, Tigra B '04-'10
- ▶ Suzuki Alto '09-'15, Alto '14-, Celerio '14-, Splash '08-'14, Wagon R '03-'08

Engine codes:

- ▶ Nissan K10B
- ▶ Opel X10XE, X12XE, Z10XE, Z10XEP, Z12XE, Z12XEP, Z14XEL, Z14XEP
- ▶ Suzuki K10B

Used equivalent to the following OE numbers:

- ▶ Adjusting tool camshafts, Opel KM-953A
- ▶ Locking pin crankshaft, Opel KM-952
- ▶ Setting gauge pulse encoder disc, Opel KM-954
- ▶ Locking pin chain tensioner, ø 2.5 mm, Opel EN-955-1
- ▶ Locking pin chain tensioner, ø 4.0 mm, Opel EN-955-2



DESCRIPTION	ARTICLE	PRICE EUR*
Engine timing tool set, Opel	26350L	49,90
Adjusting tool camshafts	26350L-1	12,90
Locking pin crankshaft	26350L-2	16,90
Setting gauge pulse encoder disc	26350L-3	19,90
Locking pin chain tensioner, ø 2,5 mm	26350L-4	4,50
Locking pin chain tensioner, ø 4,0 mm	26350L-5	5,50

ENGINE TIMING TOOL SET, OPEL

contains the most important tools for repair work on 1.0, 1.2 and 1.4 l. Opel engines with double camshaft

Suitable for the following vehicles:

- ▶ Chevrolet Aveo '11-, Cruze '10-, Orlando '12-, Trax '12-
- ▶ Opel Adam '12-'19, Ampera '11-'15, Astra J '09-'15, Cascada '13-'18, Corsa D '06-'14, Corsa E '14-, Insignia A '11-'17, Meriva B '10-'17, Mokka '12-, Zafira C '11-

Engine codes:

- ▶ Chevrolet: LDC, LDD, LUJ, LWD
- ▶ Opel: A10XEP, A12XEL, A12XER, A14NEL, A14NET, A14XEL, A14XER, A14XFL, B12XEL, B14NEH, B14NEJ, B14NEL, B14NET, B14XEJ, B14XEL, B14XER, D12XEL, D14NEH, D14NEJ, D14NEL, D14NET, D14XEL, D14XER

Used equivalent to the following OE numbers:

- ▶ Locking tool camshaft position sensor, Opel EN-49977-100
- ▶ Locking tool camshaft adjuster, Opel EN-49977-200
- ▶ Locking tool pulser wheel, Opel EN-49978
- ▶ Locking pin crankshaft, Opel KM-952
- ▶ Adjusting tool camshafts, Opel KM-953A
- ▶ Locking pin chain tensioner, ø 2.5 mm, Opel EN-955-1
- ▶ Locking pin chain tensioner, ø 4.0 mm, Opel EN-955-2



DESCRIPTION	ARTICLE	PRICE EUR*
Engine timing tool set, Opel	26362L	149,90
Locking tool camshaft position sensor	26362L-1	59,90
Locking tool camshaft adjuster	26362L-2	34,90
Locking tool pulser wheel	26362L-3	24,90
Adjusting tool camshafts	26350L-1	12,90
Locking pin crankshaft	26350L-2	16,90
Locking pin chain tensioner, ø 2,5 mm	26350L-4	4,50
Locking pin chain tensioner, ø 4,0 mm	26350L-5	5,50

ENGINE TIMING TOOL SET, CITROËN/OPEL/PEUGEOT/TOYOTA

for locking the camshaft and crankshaft on 1.0 and 1.2 petrol engines

NEW
PRODUCT

Installed in the following vehicles:

- ▶ Citroën Berlingo, C-Elysee, C1 II, C3 II, C4 II/III, C4 Cactus, C5 Aircross, C5 X, DS3, DS4
- ▶ Opel Astra L, Combo E, Corsa F, Crossland, Grandland, Mokka
- ▶ Peugeot 108, 208 I/II, 308 II/III, 508 II, 2008 I/II, 3008, 5008 I/II, Partner Tepee, Rifter
- ▶ Toyota Aygo

Engine codes:

- ▶ Opel: B12XE, B12XHL, B12XHT, D12XE, D12XHL, D12XHT, F12XE, F12XHL, F12XHT
- ▶ Citroën: HMP, HMR, HMT, HMU, HMY, HMZ, HNK, HNP, HNS, HNV, HNX, HNY, HNZ, ZMZ
- ▶ Peugeot: EB0, EB2, EB2ADT, EB2ADTD, EB2ADTS, EB2D, EB2DT, EB2DTM, EB2DTS, EB2DTSO, EB2F, EB2FA, EB2FB, EB2FD, EB2M
- ▶ Toyota: 1PP

Used equivalent to the following OE numbers:

- ▶ Locking tool camshafts, Opel EN-52127-1, PSA 0109-2A
- ▶ Locking tool flywheel, Opel EN-52127-2, PSA 0109-2B
- ▶ Blocking pin tensioning element V-ribbed belt, Opel EN-52141
- ▶ Locking tool flywheel, Opel EN-52588



DESCRIPTION	ARTICLE	PRICE EUR*
Engine timing tool set, Citroën/Opel/Peugeot/Toyota	26322L	99,90
Locking pin tensioning element V-ribbed belt	26322L-1	4,90
Locking tool camshafts	26322L-2	89,90
Locking tool flywheel	26322L-3	14,90
Locking tool flywheel	26322L-4	14,90

ENGINE TIMING TOOL SET, OPEL

for locking the camshaft and crankshaft on 1.0 ltr., 1.4 with and without turbo and 1.5 turbo engines/p>

Installed in the following vehicles:

- ▶ Opel Astra K '15-'22, Insignia B '17-, Karl '15-'19 und Mokka A '12-'20

Engine codes: B10XE, B10XL, B14XE, B14XFL, B14XFT, B14XNT, B15SFL, B15SFT, D10XE, D14XFL, D14XFT, D15SFL, D15SFT

Used equivalent to the following OE numbers:

- ▶ Crankshaft pulley puller, Opel EN-44226
- ▶ Locking pin chain tensioner, Opel EN-49073
- ▶ Adjusting ruler for camshafts, vehicles with turbocharger, Opel EN-51367
- ▶ Adjusting ruler for camshafts, vehicle without turbocharger, Opel EN-51632



DESCRIPTION	ARTICLE	PRICE EUR*
Engine timing tool set, Opel	26316L	199,90
Adjusting tool camshafts	26316L-1	39,90
Adjusting tool camshafts	26315L-2	29,70
Crankshaft pulley puller	26316L-2	130,40
Chain tensioner locking pin	26316L-3	4,90

ENGINE TIMING TOOL SET, OPEL

for locking the camshaft and crankshaft on 1.6 SIDI engines

Installed in the following vehicles:

- ▶ Opel Astra J '09-'15, Cascada '13-'19, Insignia A '08-'17, Insignia B '17-, Zafira C '11-'19

Engine codes: A16SHT, A16XHT, B16SHL, B16SHT, D16SHJ, D16SHL, D16SHT

Used equivalent to the following OE numbers:

- ▶ Locking tool camshafts, Opel EN-51148
- ▶ Pulley retaining tool, Opel EN-51147
- ▶ Locking pin chain tensioner, Opel EN-50513



DESCRIPTION	ARTICLE	PRICE EUR*
Engine timing tool set, Opel	26317L	114,90
Locking tool camshafts	26317L-1	79,90
Belt pulley retaining tool	26317L-2	82,60
Locking pin tensioner	26317L-3	4,90

ENGINE TIMING TOOL SET, OPEL, ALFA, FIAT

contains the most important tools for repair work on 1.4 and 1.6 l. VAG FSI, TSI and TFSI engines.

Suitable for the following vehicles:

- ▶ Alfa Romeo 159 '05-'11
- ▶ Chevrolet Aveo I '08-'15, Aveo II '11-'20, Cruze '09-'16, Orlando '10-'18, Trax '13-
- ▶ Fiat Croma '05-'10
- ▶ Opel Astra G '02-'06, Astra H '04-'12, Astra J '09-'15, Corsa D '0-'14, Corsa E '15-'19, Insignia A '08-'17, Meriva A '06-'10, Mokka A '12-'19, Signum '05-'08, Vectra C '05-'08, Zafira A '03-'05, Zafira B '05-'15, Zafira C '11-'19
- ▶ Saab 9-5 '10-'12

Engine codes:

- ▶ Alfa Romeo 939A4.000
- ▶ Chevrolet 2H0, LDE, LDT
- ▶ Fiat 939A4.000
- ▶ Opel A16LEL, A16LER, A16LES, A16LET, A16XER, A16XNT, A18XEL, A18XER, B16LER, B16LES, B16XER, B16XNT, B18XER, D16XER, Z16LEL, Z16LER, Z16LET, Z16XET, Z16XEP, Z16XER, Z16XNT, Z18XER
- ▶ Saab A16LET

Used equivalent to the following OE numbers:

- ▶ Adjusting tool camshafts, Opel KM-6628-A
- ▶ Locking tool camshafts, Opel EN-6340
- ▶ Locking pin tensioner, Opel EN-6333
- ▶ Locking tool flywheel, Opel EN-6625
- ▶ Locking pin tensioner V-ribbed belt, Opel KM-6130
- ▶ Locking tool flywheel, Opel KM-911



DESCRIPTION	ARTICLE	PRICE EUR*
Engine timing tool set, Opel, Alfa, Fiat	26363L	51,90
Adjusting tool camshafts	26363L-1	13,50
Locking tool camshafts	26363L-2	9,50
Locking pin tensioner	26363L-3	2,90
Locking tool flywheel	26363L-4	9,90
Locking pin tensioner V-ribbed belt	26363L-5	8,50
Locking tool flywheel	26363L-6	9,50

ENGINE ADJUSTMENT TOOL SET, ALFA ROMEO/FIAT/FORD

for checking or adjusting the timing and change the timing chain on 1.3 JTD / CDTi / TDCi diesel engines.

Suitable for:

- ▶ Alfa Romeo MiTo 2008-
- ▶ Chevrolet Aveo 2011, Cobalt 2013, Enjoy 2013, Montana 2011, Sail 2011, Sonic 2011, Spin 2012
- ▶ Citroën Nemo 2008-
- ▶ Fiat 500 2007-, Doblo 2000-2010, Doblo 2010-, Fiorino 2007-, Idea 2004-, Linea 2006-, Palio 2003-, Panda 2003-2013, Panda 2012-, Punto 1999-2012, Grande Punto 2005-, Qubo 2008-, Strada 2006-
- ▶ Ford Ka 2008-2015
- ▶ Lancia Musa 2004-2012, Ypsilon 2003-2011, Ypsilon 2011-
- ▶ Opel Agila A 2000-2007, Agila B 2008-2014, Astra H 2004-2014, Astra J 2009-2015, Combo 2004-2011, Corsa C 2000-2009, Corsa D 2006-2014, Meriva A 2003-2010, Meriva B 2010-2017, Tigra B 2004-2010
- ▶ Peugeot Bipper 2008-
- ▶ Subaru Justy III 2003-2007
- ▶ Suzuki Splash 2008-, Swift III 2005-2010, Swift IV 2010-

Engine codes:

- ▶ Alfa Romeo / Fiat / Lancia: 169A1,000, 169A5,000, 188A8,000, 188A9,000, 199A2,000, 199A3,000, 199A9,000, 199B1,000, 199B2,000, 223A9,000, 263A2,000
- ▶ Ford: 169A1,000, FD4, BAAA, BBAB, BBCB
- ▶ Opel / Vauxhall: L4i, LDP, LDV, LN9, LSF, A13DT, A13DTC, A13DTE, A13DTR, D13A, Y13DT, Z13DT, Z13DTE, Z13DTH, Z13DTJ, Z13DTR
- ▶ PSA: FHZ, F13DTE5
- ▶ Suzuki: D13A, Z13DT, Z13DTJ

Used equivalent to the following OE numbers:

- ▶ Crankshaft lock can be used as OE no. 1.870.900.300, 303-1468, 09912-38300, 0104.C
- ▶ Cam counter holder can be used as OE no. 1.871.008.600, 303-1475, 09917-68221, 0104.B
- ▶ Flywheel lock 09912-46310, EN-46785
- ▶ Flywheel lock 09916-98610, EN-955-A
- ▶ Crankshaft counterweight 1.871.000.200
- ▶ Tensioner roller lock KM-6130, 0198.J
- ▶ Spreading lever timing chain tension 1.870.900.400, 303-1469
- ▶ Camshaft lock 1.871.000.900, 303-1472, 09917-68610 EN-46781, 0104.A



DESCRIPTION	ARTICLE	PRICE EUR*
Engine adjustment tool set, Alfa Romeo/Fiat/Ford	26313L	149,90

ENGINE TIMING TOOL SET, CHEVROLET/OPEL/VAUXHALL

Contains the most important tools for repair work on 1.6 CDTi ecoFLEX diesel engines.

Suitable for the following vehicles:

- ▶ Chevrolet Trax '14-'15
- ▶ Opel/Vauxhall Astra J '09-'18, Astra K '15-'21, Insignia A '08-'17, Insignia B '17-, Meriva B '10-'17, Mokka A '12-'19, Zafira C '11-'19

Engine codes:

- ▶ Chevrolet LVL
- ▶ Opel/Vauxhall A16DTH, B16DTC, B16DTE, B16DTH, B16DTJ, B16DTL, B16DTN, B16DTR, B16DTU, D16DTE, D16DTH, D16DTI, D16DTJ, D16DTN, D16DTR

Used equivalent to the following OE numbers:

- ▶ Locking pin tensioning pulley, OE number EN-50513
- ▶ Locking tool crankshaft, OE number EN-51140
- ▶ Locking tool camshaft, OE number EN-51143
- ▶ Locking tool camshaft sprocket, OE number EN-51188
- ▶ Locking pin V-ribbed belt, OE number EN-6349 / EN-6130



DESCRIPTION	ARTICLE	PRICE EUR*
Engine timing tool set, Chevrolet/Opel/Vauxhall	26176L	69,90
Camshaft retainer tool	26176L-1	17,50
Crankshaft retainer tool	26176L-2	105,90
Locking pin tensioner	26317L-3	4,90
Cam wheel retainer tool	26176L-4	59,90
Screw set	26176L-5	6,50
Locking pin tensioner V-ribbed belt	26363L-5	8,50

ENGINE ADJUSTMENT TOOL SET, CADILLAC/OPEL/SAAB

for operations on the timing chain with 2.0 l petrol engines with turbo, installed in the following vehicles:

- ▶ Cadillac: BLS Wagon
- ▶ Opel: Signum, Vectra C
- ▶ Saab: 9-3 (YS3F)

Engine codes: B207E, B207L, Z20NET (L8Q)

Used equivalent to the following OE numbers:

- ▶ KM-J-38122-A
- ▶ KM-6362
- ▶ KM-6077
- ▶ EN-48366
- ▶ 08 396 046
- ▶ 08 396 210
- ▶ 08 396 392

4-piece



DESCRIPTION	ARTICLE	PRICE EUR*
Engine adjustment tool set, Cadillac/Opel/Saab	26199L	44,90
Camshaft alignment tool, 2-piece	26199L-1	68,90
Camshaft adjustment tool, Opel	26199L-2	67,60

ENGINE ADJUSTMENT TOOL SET, CHEVROLET/OPEL/SAAB

for operations on the timing chain at 2.0 and 2.4 l turbocharged petrol engines, installed in Opel, Chevrolet and Saab vehicles.

Installed in the following vehicles:

- ▶ Chevrolet Captiva (C100 / C140)
- ▶ Opel Antara, Astra J, Insignia A, Insignia B
- ▶ Saab 9-3 (YS3F), 9-5 (YS3G)

Motor codes: A20NET (LHU), A20NFT (LHU), A20NHT (LDK / LTG), A24XE (LES), B20NFT (LHU / LTG)

Used equivalent to the following OE numbers:

- ▶ EN-48953
- ▶ EN-49212
- ▶ EN-48585
- ▶ EN-43653
- ▶ EN-45027

12-piece



DESCRIPTION	ARTICLE	PRICE EUR*
Engine adjustment tool set, Chevrolet/Opel/Saab	26198L	199,90

ENGINE ADJUSTMENT TOOL SET, CHEVROLET/OPEL

for 2.0 l CDI / VCDI Common Rail diesel engines.

For locking the crankshaft and camshaft while adjusting the timing e.g. for toothed belt replacement or engine repairs.

Suitable for:

- ▶ Opel (Vauxhall) Antara, Insignia
- ▶ Chevrolet Captiva, Cruze, Epica, Lacetti, Nubira

With engine code Z20DM / Z20DMH (LLW) / Z20S / Z20S1 / RA420

Used equivalent to the following OE numbers:

- ▶ Crankshaft fixation EN-48246
- ▶ Camshaft fixation EN-48245



DESCRIPTION	ARTICLE	PRICE EUR*
Engine adjustment tool set, Chevrolet/Opel	26130L	36,90

ENGINE ADJUSTMENT TOOL SET, OPEL/VAUXHALL

for professional engine servicing on 2.0 l CDTi engines from year 2014, used in the following vehicles:

- ▶ Antara
- ▶ Cascada
- ▶ Insignia A
- ▶ Insignia B
- ▶ Zafira C

Engine codes: B20DTH, B20DTR, D20DTH, D20DTR

Used equivalent to the following OE numbers:

- ▶ EN-955-2
- ▶ EN-51411
- ▶ EN-51412
- ▶ EN-51413
- ▶ EN-51414



DESCRIPTION	ARTICLE	PRICE EUR*
Engine adjustment tool set, Opel/Vauxhall	26187L	199,90
Blocking tool high pressure pump	26187L-1	115,50
Camshaft locking tool	26187L-2	12,90
Crankshaft locking	26187L-3	58,90
Crankshaft holding tool	26187L-4	124,90
Locking pin	26187L-5	6,90
Locking pin	26187L-6	6,90
Screws	26187L-7	1,90

ENGINE ADJUSTMENT TOOL SET, OPEL/VAUXHALL

for adjusting the timing chain in the cylinder head. This is an extension set to 26187L.

Suitable for:

- ▶ Antara
- ▶ Cascada
- ▶ Insignia A
- ▶ Insignia B
- ▶ Zafira C

Engine code: B20DTH

Used equivalent to OE numbers:

- ▶ EN-51415
- ▶ EN-51418

Extension set for 26187L!



DESCRIPTION	ARTICLE	PRICE EUR*
Engine adjustment tool set, Opel/Vauxhall	26190L	139,90

LOCKING TOOL, OPEL ECOTEC 1,4 + 1,6 L

for locking the camshafts for Opel Tigra B, Sintra, Vectra, Calibra and Omega engines with 1.4l / 1.6l / 1.8l with engine code X14XE, X16SEJ, X16XEL, X18XE1, Y16XE, Z14XE, Z16XE, Z16YNG, Z18XE, Z18XEL.
Used equivalent to OE number KM-852.



DESCRIPTION	ARTICLE	PRICE EUR*
Locking tool, Opel Ecotec 1,4 + 1,6 l	26096L	12,90

LOCKING TOOL OPEL ECOTEC 1,8+2,0 L

for locking the camshafts for Astra, Omega B, Vectra B, Calibra engines.

- ▶ engine code: C20SEL, X18XE, X20XE, X22SE, X22XE, Y22SE, Y22XE, Z20LEH, Z20LEL, Z20LER, Z20LET, Z22XE

Used equivalent to the following OE no.:

- ▶ Opel KM-853



DESCRIPTION	ARTICLE	PRICE EUR*
Locking tool Opel Ecotec 1,8+2,0 l	26095L	9,90

LOCKING TOOL SAAB/OPEL LEFT

for locking the camshafts for Opel Sintra, Vectra, Calibra as well as Saab 900 and 9000

- ▶ Opel engines with 2.5l and 3.0l
- ▶ Saab engines with 2.5l and 3.0l

For left- hand shafts (green model)

Motorcode: C25XE, X25XE, X25XEI, X30XE, Y26SE, Y32SE, Z32SE, B308E, B308I



DESCRIPTION	ARTICLE	PRICE EUR*
Locking tool Saab/Opel left	26097L	4,90

LOCKING TOOL SAAB/OPEL RIGHT

for locking the camshafts for Opel Sintra, Vectra, Calibra as well as Saab 900 and 9000

- ▶ Opel engines with 2.5l and 3.0l
- ▶ Saab engines with 2.5l and 3.0l

For right- hand shafts (red model)

Motorcode: C25XE, X25XE, X25XEI, X30XE, Y26SE, Y32SE, Z32SE, B308E, B308I



DESCRIPTION	ARTICLE	PRICE EUR*
Locking tool Saab/Opel right	26098L	27,50

CRANKSHAFT COUNTERHOLDER FOR OPEL 1.0 / 1.2 / 1.4 L ECOFLEX

suitable for Opel Adam, Astra J, Cascada, Corsa D, Insignia, Meriva B, Mokka, Zafira C with 1.0 / 1.2 / 1.4 l ecoFlex engines.

For holding the crankshaft pulley and for releasing the central fixing screw. With the handle included, the counterholder can be extended by 65 cm, thus offering the possibility of releasing fixed screwed connections. An additional 1/2" drive on the anvil alternatively allows use with a sliding handle.

Engine codes: A10XEP, A12XEL (LWD), A12XER (LDC), A14NEL (LUH), A14NET (LUJ), A14XEL (LDD), A14XER (LDD)

Used equivalent to OE numbers:

- ▶ Counterholder basic body (equivalent to OE EN-49979)
- ▶ Extension for counterholder (equivalent to OE EN-956-1)
- ▶ Adapter, 2-piece (equivalent to OE EN49979-100)



DESCRIPTION	ARTICLE	PRICE EUR*
Crankshaft counterholder for Opel 1,0 / 1,2 / 1,4 l ecoFlex	10566L	179,90

CAMSHAFT RETAINER TOOL FOR FIAT/FORD/OPEL/PSA/SUZUKI

for holding the camshaft when loosening and tightening the camshaft gear screw connection.

For the use on popular 1.3 JTD diesel engines, e.g. Citroën, Peugeot, Fiat, Ford and Alfa Romeo.

Motorcodes:

- ▶ Alfa Romeo: 199A3.000, 199B4.000
- ▶ Chrysler: 199B1.000
- ▶ Fiat: 169A1.000, 169A5.000, 188A8.000, 188A9.000, 199A2.000, 199A3.000, 199A9.000, 199B2.000, 199B4.000, 199B8.000, 223A9.000, 225A2.000, 263A2.000, 312A8.000, 330A1.000
- ▶ Ford: 169A1.000 (FD4)/BAAA
- ▶ Lancia: 188A9.000, 199A2.000, 199A3.000, 199A9.000, 199B1.000, 843A2.000
- ▶ Opel/Vauxhall: A13DTC, A13DTE, A13DTR, D13A, LN9 (263A2.000), LN9/A13DTC, LSF/A13DTC, LSF/A13DTE, Y13DT, Z13DT, Z13DTE, Z13DTH, Z13DTI, Z13DTJ, Z13DTR

OE reference:

- ▶ OE Ford: 303-1475
- ▶ OE Fiat: 1871 008 600
- ▶ OE Citroën: 0104-B

Suitable for:

- ▶ Alfa Romeo: Mito
- ▶ Citroën: Nemo
- ▶ Peugeot: Bipper
- ▶ Fiat: 500 / 500 C, Doblo / Doblo Cargo, Fiorino, Grande Punto, Idea, Linea, Panda / Panda Classic, Punto / Punto Classic, Punto Evo, Qubo
- ▶ Ford: Ka
- ▶ Lancia: Musa, Ypsilon
- ▶ Suzuki: Ignis, Splash, Swift, Wagon R+
- ▶ Vauxhall / Opel: Agila / Agila B, Astra G / Astra H, Combo C / Combo D, Corsa C / Corsa D, Meriva A / Meriva B, Tigra B, Zafira B



DESCRIPTION	ARTICLE	PRICE EUR*
Camshaft retainer tool for Fiat/Ford/Opel/PSA/Suzuki	10592L	39,90

ENGINE TIMING TOOL SET, FORD

Very comprehensive universal set for vehicles with Ford petrol and diesel engines. Includes tools for locking the flywheel, crankshaft and camshaft and for adjusting the timing belt tension.

Installed in the following vehicles:

- ▶ Ford B-Max, C-Max, Ecosport, Escort, Fiesta, Courier, Focus, Galaxy, Ka, Kuga, Mondeo, Orion, Sierra, S-Max, Transit
- ▶ Mazda 2, CX-7

Suitable for petrol engines:

- ▶ 1.25, 1.4 16V, 1.8 Sci

Diesel engines:

- ▶ 1.4, 1.5 EcoBlue, 1.6, 1.8, 2.5 D/TD/TDCi

NEW
PRODUCT



DESCRIPTION	ARTICLE	PRICE EUR*
Engine timing tool set, Ford	26389L	119,90
Adjusting tool camshafts	26350L-1	12,90
Locking tool flywheel	26381L-24	5,90
Locking tool camshaft	26373L-2	5,90
Locking pin injection pump	26389L-1	6,90
Adjusting tool camshafts	26389L-2	14,90
Adjustment tool crankshaft sensor	26389L-3	9,90
Locking tool flywheel	26318L-5	39,90
Locking tool crankshaft	26389L-4	6,90
Locking pin injection pump	26383L-10	5,90
Locking tool crankshaft	26372L-1	4,90
Locking tool crankshaft	26372L-2	4,90
Locking plate tensioner	26366L	3,90
Locking pin camshaft/fuel pump	26367L	11,16
Locking tool crankshaft	26368L	11,90
Locking tool camshaft	26383L-7	3,90
Feeler gauge	26389L-5	2,90
Locking pin crankshaft	26361L-1	6,80
Locking tool crankshaft	26389L-6	7,90
Locking pin injection pump	26389L-7	5,90
Locking pin injection pump	26389L-8	3,90
Locking pin camshaft	26389L-9	4,90

www.tool-is.com

TAKE A LOOK AND SEE FOR YOURSELF!

DON'T SEARCH. BUT FIND.

TOOL-IS FINDS EVERY TOOL FOR YOU.

Stop playing hide-and-seek: there's nothing worse than needing a tool and not finding it or only having a dim memory of it. We know this. That's why we invented TOOL-IS: the online tool search engine from SW Stahl.

Availability, promotion periods and prices are displayed in real time - it couldn't be faster or more up-to-date. faster than ever. What's more, thanks to the various search options, you're sure to find what you're looking for - even if you only have a few points of reference for your search.

From now on, TOOL-IS can do even more. Or rather: you can do even more. You can TOOL-IS on mobile devices (i.e. smartphones or tablets).



**REGISTER NOW AND
VIEW ADDITIONAL CONTENT!**

ENGINE TIMING TOOL SET, FORD

for locking the camshaft and crankshaft on 1.0 EcoBoost engines.

**NEW
PRODUCT**

Installed in the following vehicles:

- ▶ Ford C-Max II '10-'19, Fiesta VII '17-, Focus IV '18-, Puma '19-, Transit Connect '13-'22

Engine codes: B3DA, B3GA, B3GB, B7DA, B7JA, B7JB, B7JC, B7JE, B7JG, BZJA, MODC, MOJA

Used equivalent to the following OE numbers:

- ▶ Locking tool camshafts, Ford 303-1661/1 und /2
- ▶ Socket spanner camshaft adjuster, Ford 303-1661/3
- ▶ Locking tool camshafts, Ford 303-1604
- ▶ Crankshaft locking pin, Ford 303-732
- ▶ Locking tool flywheel, Ford 303-1643



DESCRIPTION	ARTICLE	PRICE EUR*
Engine timing tool set, Ford	26320L	249,90
Locking tool camshafts	26320L-1	189,90
Special socket, 1/2"	04466L	6,20
Locking tool camshafts	26320L-2	0,00
Locking pin crankshaft	26361L-1	6,80
Locking tool flywheel	26319L-2	59,90

ENGINE TIMING TOOL SET, FORD

for locking the camshaft and crankshaft on 1.25, 1.4, 1.6, 1.8, 2.0 and 2.3 Ford engines.

**NEW
PRODUCT**

Installed in the following vehicles:

- ▶ Ford B-Max '12-'17, Cougar '98-'02, C-Max I '03-'10, C-Max II '10-'19, Fiesta IV '95-'01, Fiesta V '01-'08, Fiesta VI '08-'17, Courier '96-'02, Focus I '98-'04, Focus II '04-'10, Fusion '02-'12, Galaxy II '06-'14, Mondeo I '93-'96, Mondeo II '96-'00, Mondeo III '00-'07, Mondeo IV '07-'15, Puma '97-'01, S-Max I '06-'14, Tourneo Connect '02-'13, Transit '06-'13, Transit Connect '02-'13

Engine codes: ALDA, AOBA, AOBC, AODA, AODB, AODE, AOWA, AOWB, ASDA, ASDB, CGBA, CGBB, CHBA, CHBB, CJBA, CJBB, CSDA, CSDB, DHA, DHB, DHC, DHD, DHE, DHF, DHG, EDDB, EDBB, EDBC, EDBD, EDDB, EDDC, EDDD, EDDF, EYDB, EYDC, EYDD, EYDE, EYDF, EYDG, EYDI, EYDJ, EYDL, EYPA, EYPB, EYPC, EYPD, FHA, FHD, FHE, FHF, FUJA, FUJB, FXDA, FXDB, FXDC, FXDD, FYDA, FYDB, FYDC, FYDD, FYDH, FYJA, FYJB, FYJC, GZFA, GZFB, GZFC, HMDA, HWDA, HWDB, L1L, L1N, L1Q, L1T, L1V, L1W, N4JB, NGA, NGB, NGC, NGD, Q7DA, QQDA, QQDB, QQDC, RTJA, RTJB, RTJC, RTJD, SEBA, SEWA, SHDA, SHDB, SHDC, SPJA, SPJC, SPJD, SPJE, SYDA, TBBA, TBBB, TBWA, TBWB, UADA, UTJA

Used equivalent to the following OE numbers:

- ▶ Crankshaft locking tool, Ford 303-507
- ▶ Crankshaft locking pin, Ford 303-748
- ▶ Crankshaft locking tool, Ford 303-574
- ▶ Adjusting ruler for camshafts, Ford 303-376B



DESCRIPTION	ARTICLE	PRICE EUR*
Engine timing tool set, Ford	26372L	19,90
Locking tool crankshaft	26372L-1	4,90
Locking pin crankshaft	26318L-4	4,90
Locking tool crankshaft	26372L-2	4,90
Adjusting tool camshafts	26350L-1	12,90

ENGINE ADJUSTMENT TOOL SET, FORD

for working on Ford petrol engines and identical engines, e.g. from Mazda.

Fits:

- ▶ 1.25 / 1.4 / 1.6 / 1.7 Zetec / 1.8 / RS 1800 / 2.0 Zetec ('91 - '09) Motoren bei Escort, Fiesta, Puma, Focus, C-Max, Fusion, Mondeo, Orion, Tourneo, Cougar, Transit / Mazda 121

Used equivalent to the following OE numbers:

- ▶ 1x crankshaft fixing mandrel 303-507 / 21-210
- ▶ 1x crankshaft fixing mandrel 303-748 / 21-259
- ▶ 1x crankshaft fixing mandrel 303-574 / 21-163
- ▶ 1x camshaft ruler 21-162B / 21-162 / 303-367 / 303-376



DESCRIPTION	ARTICLE	PRICE EUR*
Engine adjustment tool set, Ford	26043L	19,95
Camshaft setting gauge	26053L-16	0,00
Crankshaft retainer pin	26059L-5	8,30
Crankshaft retainer pin	26059L-4	9,70
Crankshaft locking tool	26181L-1	0,00

ENGINE TIMING TOOL SET, FORD

for locking the camshaft and crankshaft on 1.5 and 1.6 EcoBoost engines.

Installed in the following vehicles:

- ▶ Ford C-Max II, Fiesta VI, Focus III, Galaxy II/III, Ka+ III, Kuga II, Mondeo IV/V, S-Max, Transit Connect, Tourneo Connect

Engine codes: B2KA, C15HDTX, JQDA, JQDB, JQGA, JQMA, JQMB, JTBA, JTBB, JTDA, JTDB, JTJA, JTJB, JTJC, JTWA, JTWB, M8DA, M8DB, M8DD, M8DE, M8DF, M9DA, M9DB, UNCA, UNCB, UNCE, UNCF, UNCI, UNCJ, UNCK, UNCN, UNCP, YSKD, YSKE, YUDA

Used equivalent to the following OE numbers:

- ▶ Locking tool flywheel, Ford 303-393A
- ▶ Locking tool crankshaft, Ford 303-732
- ▶ Locking tool crankshaft, Ford 303-748
- ▶ Locking pin tensioner pulley, Ford 303-1054
- ▶ Locking tool camshaft sprockets, Ford 303-1097
- ▶ Adjusting tool crankshaft pulley, Ford 303-1550
- ▶ Locking tool camshafts, Ford 303-1552



DESCRIPTION	ARTICLE	PRICE EUR*
Engine timing tool set, Ford	26318L	114,90
Locking tool camshaft	26318L-1	33,20
Locking tool camshafts	26318L-2	29,90
Belt pulley adjustment tool	26318L-3	14,90
Locking pin crankshaft	26318L-4	4,90
Locking tool flywheel	26318L-5	39,90
Locking pin tensioner V-ribbed belt	26318L-6	2,90
Locking pin crankshaft	26361L-1	6,80

ENGINE TIMING TOOL SET, FORD

for locking the camshaft and crankshaft on 1.5 EcoBoost engines.

Installed in the following vehicles:

- ▶ Ford Fiesta VII '17-, Focus IV '18-, Puma '19-, Kuga III '19-

Engine codes: UNDA, Y1DA, Y2DA, YZDA, YZDB, YZJA

Used equivalent to the following OE numbers:

- ▶ Locking tool camshafts, Ford 303-1649
- ▶ Locking tool flywheel, Ford 303-1643
- ▶ Locking pin chain tensioner



DESCRIPTION	ARTICLE	PRICE EUR*
Engine timing tool set, Ford	26321L	169,90
Locking tool camshafts	26321L-1	134,90
Locking tool flywheel	26319L-2	59,90
Locking pin chain tensioner	26321L-2	8,90

ENGINE ADJUSTMENT TOOL SET, FORD/MAZDA/VOLVO

suitable for 1.6 l und 2.0 l engines, e.g. for the following vehicles:

- ▶ Ford: B-Max (12-), C-Max (07-10), C-Max (10-), Fiesta (08-), Focus (04-11), Focus C-Max (03-07), Focus (11-), Galaxy (06-15), Grand C-Max (06-15), Kuga (12-), Mondeo (10-15), S-Max (06-15), Tourneo Connect (13-), Grand Tourneo Connect (13-), Transit Connect (13-)
- ▶ Mazda: Mazda 5 (CW) (10-)
- ▶ Volvo: S60 (10-), S80 (06-), V40 (12-), V60 (10-), V70 (07-), XC60 (08-17)

Engine codes:

- ▶ 1.6: B4164T, B4164T2, B4164T3, HXDA, HXDB, HXJA, HXJB, IQDA, IQDB, IQJA, JQDA, JQDB, JQGA, JQMA, JQMB, JTDA, JTDB, JTJA, JTMA, JTWB, MUDA, PNDA, RVJA, SIDA, U5JA, XTDA
- ▶ 2.0: B4204T6, B4204T7, MGDA, MZR 2.0 (LF), R9DA, R9DB, R9DC, R9DD, TNBA, TNBB, TNWA, TNWB, TPBA, TPWA

Used equivalent to the following OE numbers:

- ▶ Camshaft fixing tool (equivalent to OE 303-1565)
- ▶ Camshaft setting tool (equivalent to OE 303-1504 / 9.997405)
- ▶ Crankshaft sensor setting tool (equivalent to OE 303-1521 / 9.997416)
- ▶ Crankshaft locking pin (equivalent to OE 303-748 / 9.997406)
- ▶ Tensioner pin, 2-piece (equivalent to OE 303-1054)
- ▶ Camshaft locking tool (equivalent to OE 303-1097 / 9.997429)
- ▶ Crankshaft pulley alignment tool (equivalent to OE 303-1550 / 9.997431)
- ▶ Crankshaft setting tool (equivalent to OE 9.997415)
- ▶ Flywheel locking tool (equivalent to OE 303-393)



DESCRIPTION	ARTICLE	PRICE EUR*
Engine adjustment tool set, Ford/Mazda/Volvo	26181L	199,90
Camshaft fixing tool	26181L-5	35,90
Camshaft setting tool	26181L-7	77,90
Crankshaft sensor setting tool	26181L-6	41,90
Locking pin tensioner V-ribbed belt	26318L-6	2,90
Locking tool camshafts	26318L-2	29,90
Belt pulley adjustment tool	26318L-3	14,90
Crankshaft setting tool	26181L-8	101,90
Locking tool flywheel	26318L-5	39,90
Locking pin crankshaft	26318L-4	4,90

ENGINE TIMING TOOL SET, FORD

for locking the camshaft and crankshaft on 1.6 16V Ti-VCT as well as 2.0 and 2.2 TDCi engines.

Installed in the following vehicles:

- ▶ Ford C-Max I '03-'10, C-Max II '10-'19, Focus II '04-'10, Focus III '10-'18, Galaxy II '06-'14, Galaxy III '15-, Kuga I '08-'12, Kuga II '12-'19, Mondeo IV '07-'15, Mondeo V '15-, S-Max I '06-'14, S-Max II '15-

Engine codes: AZBC, AZWA, AZWC, G6DA, G6DB, G6DC, G6DD, G6DE, G6DF, G6DG, HXDA, IXDA, KLBA, KLWA, KNBA, KNWA, LPBA, Q4BA, Q4WA, QXBA, QXBB, QXWA, QXWB, QXWC, SIDA, T7CA, T7CC, T7CD, T7CE, T7CF, T7CI, T7CJ, T7CK, T7CL, T7CN, T7CP, T7CQ, T7DA, T7DB, T7DC, T7DD, T7MA, T7MB, T7MC, T7MD, T8CA, T8CB, T8CC, T8CD, T8CG, T8CH, T8CI, T8CJ, T8CL, T8DA, T8DE, T8MA, T8MB, T8MC, T9CA, T9CB, T9CC, T9CD, TXBA, TXBB, TXDA, TXDB, TXMA, TXWA, TYBA, TYDA, TYMA, TYWA, UFBA, UFBB, UFCA, UFCD, UFDA, UFDB, UFMA, UFWA, UKBA, UKBB, UKDA, UKDB, UKMA, UKWA, XRMA, XRGB

Used equivalent to the following OE numbers:

- ▶ Crankshaft locking tool, Ford 303-1059
- ▶ Locking pin tensioner V-ribbed belt, Ford 303-1054
- ▶ Locking tool camshaft, Ford 303-735
- ▶ Crankshaft locking pin, Ford 303-748
- ▶ Locking tool camshafts, Ford 303-1097



DESCRIPTION	ARTICLE	PRICE EUR*
Engine timing tool set, Ford	26373L	44,90
Locking tool crankshaft	26373L-1	9,90
Locking pin tensioner V-ribbed belt	26318L-6	2,90
Locking tool camshaft	26373L-2	5,90
Locking pin crankshaft	26318L-4	4,90
Locking tool camshafts	26318L-2	29,90

ENGINE TIMING TOOL SET, FORD

for locking the camshaft and crankshaft on 2.0 EcoBlue engines.

Installed in the following vehicles:

- ▶ Ford Focus IV, Galaxy III, Kuga III, Mondeo V, Ranger, S-Max, Tourneo Custom, Transit Custom, Transit V363

Engine codes: BCCC, BCCD, BCDA, BCFA, BCFB, BCFD, BCRA, BCRB, BJFA, BJFB, BJFC, BJFD, BJRA, BKFA, BKFB, BKFC, BKFD, BKRA, BKRB, BLFA, BLFB, BLFC, BLFD, BLHA, BLRA, BLRB, NOHA, POFA, POFB, T20DDOJ, YLCB, YLCC, YLDA, YLDC, YLF6, YLFA, YLFB, YLFS, YLR6, YLRA, YMCB, YMCC, YMDA, YMFA, YMFB, YMFS, YMHA, YMR6, YMRA, YNCA, YNF6, YNFA, YNFB, YNFS, YNHA, YNR6, YNRA

Used equivalent to the following OE numbers:

- ▶ Adjustment tool crankshaft, Ford 303-1637
- ▶ Locking tool flywheel, Ford 303-1643
- ▶ Timing belt installation tool, Ford 303-1650
- ▶ Crankshaft pulley puller, Ford 303-1657



DESCRIPTION	ARTICLE	PRICE EUR*
Engine timing tool set, Ford	26319L	209,90
Crankshaft adjustment tool	26319L-1	79,90
Locking tool flywheel	26319L-2	59,90
Timing belt fitting tool	26319L-3	89,90
Crankshaft pulley puller	26319L-4	59,90

ENGINE ADJUSTMENT TOOL SET, FORD

for locking the camshaft, crankshaft and injection pump during the following work:

- ▶ Setting the timing
- ▶ Replacing the timing chain
- ▶ Replacing the cylinder head gasket
- ▶ Replacing the injection pump

Used equivalent to the following OE numbers:

- ▶ Crankshaft lock 303 675 (21-234)
- ▶ Pump wheel lock 303-681 (21-240)

For Ford e.g. Mondeo, Transit, etc., from model year 2001 - 2004, with 2.0L and 2.4L 16V TDDi / TDCi diesel engines.

Engine codes: FMBA, FMBB, D5BA, ABFA, D3FA, F3FA, D2FA, D4FA, F4FA



DESCRIPTION	ARTICLE	PRICE EUR*
Engine adjustment tool set, Ford	26113L	99,90

ENGINE ADJUSTMENT TOOL SET, FORD

for professional engine servicing.

Suitable for 2.0 - 2.2 - 2.4 - 3.2 l Ford Duratorq diesel engines in the following vehicles:

- ▶ Ford Duratorq (Puma), Ford: Mondeo (00-07), Transit (00-11)
- ▶ Citroën: Relay (06-11), Jumper II
- ▶ Fiat: Ducato (06-11)
- ▶ Jaguar: X-Type (01-10)
- ▶ Land Rover: Defender (07-11)
- ▶ LDV: Convoy (02-06)
- ▶ Peugeot: Boxer III (06-11)

Engine codes:

2.0l: ABFA, D3FA, D5BA, D6BA, F3FA, F5FA, FMBA, HJBA, HJBB, HJBC, HJBE, N7BA, N7BB

2.2l: QJBA(BG), QJBB, QJBC, QJBD

2.2l: 4HM, 4HU, 4HV, P8FA, P22DTE, QVFA, QWFA

2.4l: 244DT, DOFA, D2FA, D2FB, D4FA, F4FA, FXFA, H9FA, H9FB, HEFA, HFFA, JXFA, PHFA, ZSD 424

3.2l: SAFA

Used equivalent to the following OEM numbers:

- ▶ Pump removal tool 303-249
- ▶ Camshaft locking tool 303-675
- ▶ Camshaft radial gasket 303-679A
- ▶ Adjustment tool for engine covers OE 303-682
- ▶ Flywheel locking bolt 303-698
- ▶ Retaining tool for high-pressure pumps 303-1151
- ▶ Injection pump arrester tool 303-1317



DESCRIPTION	ARTICLE	PRICE EUR*
Engine adjustment tool set, Ford	26173L	94,90
Adjustment tool	26173L-1	19,90
Camshaft radial gasket	26173L-2	16,90
Retaining tool	26173L-3	16,90
Pump removal tool	26173L-4	60,90
Camshaft locking tool	26173L-5	23,90
Locking tool crankshaft	26389L-6	7,90
Locking pin	26173L-7	19,90
Timing belt tensioner locking pin	26173L-8	3,64
Injection pump arrester tool	26173L-9	20,86
Locating screw	26173L-10	52,90

CRANKSHAFT ARRESTER TOOL FOR FORD

for blocking the crankshaft when changing the timing chain or when setting the timing.

Suitable for Ford Transit 2,2 TDCi 74 / 92 / 99 / 114 KW engines from 2006.

Engine codes:
CVRA, CVRB, CYRA, CYRB, DRRR, DRRB, USRA, USRB

Used equivalent to OE number 303-1562.



DESCRIPTION	ARTICLE	PRICE EUR*
Crankshaft arrester tool for Ford	26205L	4,50

ENGINE ADJUSTMENT TOOL SET, FORD

for locking the crankshaft and camshaft when working on the engine control, e.g. at the timing belt change.

Suitable for petrol and diesel engines in the following vehicles:

- ▶ Ford: Focus II 2.5 ST/RS/RS500, Kuga I 2.5, Mondeo IV 2.5, S-Max 2.5 ST

Motor Codes:
2.5 Turbo (Euro4) - HUBA, HUWA, HYDA, HYDB, HYDC, JZDA

To use as the following OE numbers:

- ▶ Crankshaft holding tool 303-1179
- ▶ Camshaft adjusting tool 303-1178
- ▶ Crankshaft adjusting tool 303-1182
- ▶ Tensioning roller fixing pin 303-1054



DESCRIPTION	ARTICLE	PRICE EUR*
Engine adjustment tool set, Ford	26179L	174,95
Crankshaft holding tool	26179L-1	54,80
Camshaft adjustment tool	26179L-2	221,90
Hex screw	26179L-3	8,50
Crankshaft adjustment tool	26179L-4	29,90

ENGINE TIMING TOOL SET, CITROËN/PEUGEOT

Very comprehensive universal set for vehicles with PSA petrol and diesel engines. Includes tools for locking the flywheel, crankshaft and camshaft and for adjusting the timing belt tension.

Installed in the following vehicles:

- ▶ Citroën AX, Berlingo, BX, C15, C2, C3, C4, C5, C8, DS4, DS5, Evasion, Jumpy, Nemo, Saxo, Xantia, Xsara, ZX
- ▶ Fiat Scudo, Ulysse, Ducato
- ▶ Lancia Phedra, Zeta
- ▶ Peugeot 106, 205, 206, 207, 306, 307, 308, 309, 406, 407, 508, 607, 806, 807, 1007, 3008, 5008, Bipper, Expert, Partner, Boxer
- ▶ Suzuki Grand Vitara

Suitable for petrol engines:

- ▶ 1.1, 1.4, 1.4 16V, 1.6, 1.6 16V, 1.8 16V, 2.0, 2.0 16V

Diesel engines:

- ▶ 1.9, 2.0, 2.2 D/TD/TDI/HDI/JTD



NEW PRODUCT

DESCRIPTION	ARTICLE	PRICE EUR*
Engine timing tool set, Citroën/Peugeot	26381L	169,90
Locking tool flywheel	26381L-1	11,90
Tensioning wrench, hexagon socket SW 8	26381L-2	12,90
Locking tool flywheel	26381L-3	6,90
Locking tool flywheel	26381L-4	6,90
Adjusting tool tensioner	26381L-5	4,90
Locking tool camshaft	26381L-6	5,90
Adjusting tool tensioner	26381L-7	8,90

ENGINE TIMING TOOL SET, CITROËN/PEUGEOT

DESCRIPTION	ARTICLE	PRICE EUR*
Adjusting tool tensioner	26381L-8	8,90
Belt pulley puller	26381L-9	16,90
Retaining clip timing belt	26381L-10	4,90
Locking tool flywheel	26381L-11	5,90
Adjusting tool tensioner	26381L-12	26,90
Locking tool flywheel	26377L	6,90
Adjusting tool tensioner	26381L-13	8,90
Locking tool, ø 5 mm	26381L-14	8,90
Locking tool flywheel	26381L-15	12,90
Locking tool camshaft	26381L-16	4,90
Locking tool crankshaft	26381L-17	14,90
Locking tool flywheel	26381L-18	9,90
Locking tool flywheel	26381L-19	7,90
Locking tool camshaft	26381L-20	4,90
Locking tool camshaft	26373L-2	5,90
Locking tool camshaft	26381L-21	4,90
Locking tool injection pump	26381L-22	4,90
Locking tool injection pump	26381L-23	4,90
Locking tool flywheel	26381L-24	5,90
Locking tool crankshaft	26381L-25	5,90
Locking tool crankshaft	26381L-26	8,90
Locking tool camshaft	26381L-27	7,90
Locking tool camshaft	26381L-28	8,90
Locking tool tensioning pulley	26381L-29	1,90
Centering clamp timing belt sprocket	26381L-30	2,90
Locking tool crankshaft	26381L-31	2,90

ENGINE TIMING TOOL SET, FIAT/OPEL

for locking the camshaft and crankshaft on 1.2 and 1.4 petrol engines

Installed in the following vehicles:

- ▶ Alfa Romeo Giulietta '10-'20, Mito '08-'18
- ▶ Fiat Brava I, Bravo I, Bravo II, Doblo 263, Idea, Linea, Marea, Palio, Panda '06-, Punto 176, Punto 188, Grande Punto 199, Stilo 192, Tipo 356, 500 312, 500 351
- ▶ Lancia Delta '08-'14, Musa '04-'12, Y '95-'03, Ypsilon '03-'11
- ▶ Opel Combo Tour '11-'18

Engine codes:

- ▶ Fiat: 169A3, 176B9, 182B2, 188A5, 192B2, 198A1, 198A4, 199A6, 199A8, 312B3, 312B4, 312B6, 55277, 843A1, 940A6, 940B1, 940B7, 940B8, 955A1
- ▶ Opel: A14FC, A14FP

Used equivalent to the following OE numbers:

- ▶ Locking tool camshaft sprocket, Opel EN-50781
- ▶ Locking tool crankshaft, Opel EN-50780, Fiat 2.000.004.500, Ford 303-1480
- ▶ Locking tool camshafts, Opel EN-46781
- ▶ Adjusting tool tensioner, Opel EN-50782, Fiat 1.860.987.000, Ford 303-1560
- ▶ Alignment tool TDC position, Fiat 1860992000
- ▶ Locking tool flywheel, Fiat 1871000400

DESCRIPTION	ARTICLE	PRICE EUR*
Engine timing tool set, Fiat/Opel	26323L	109,90
Locking tool camshaft sprocket	26323L-1	19,90
Locking tool crankshaft	26358L-2	12,90
Locking tool camshafts	26323L-3	39,90
Adjusting tool tensioner	26358L-1	9,90
Alignment tool TDC position	26323L-4	29,90
Locking tool flywheel	26323L-2	24,90



NEW PRODUCT

ENGINE SETTING TOOL SET, FIAT/PSA

for 2.2l, 2.3l, 3.0l JTD engines (identical to PSA), installed in the following vehicles:

- ▶ Citroën Jumper and Peugeot Boxer (22 DT and F30 DT engines)
- ▶ Fiat Ducato 2.2l, 2.3l, 3.0l JTD (identical to PSA)
- ▶ Fiat 2.2l JTD 4HV, 2.3l JTD F1AE0481D / F1AE0481N, 3.0l JTD
- ▶ PSA 22DT 4HV/4HU, F30DT



DESCRIPTION	ARTICLE	PRICE EUR*
Engine setting tool set, Fiat/PSA	26023L	129,90

LOCKING TOOL FLYWHEEL

for locking the flywheel during repair work on the timing drive

Used equivalent to the following OE number:

- ▶ Fiat 1.860.161.000
- ▶ Mercedes 607.589.01.40.00
- ▶ PSA 0153.A

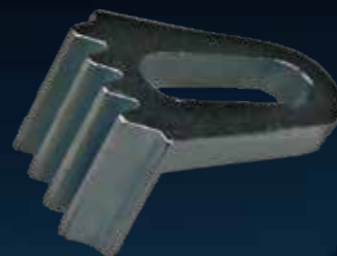

NEW PRODUCT

DESCRIPTION	ARTICLE	PRICE EUR*
Locking tool flywheel	26377L	6,90

ENGINE TIMING TOOL SET, RENAULT

Very comprehensive universal set for vehicles with Renault petrol and diesel engines. Includes tools for locking the flywheel, crankshaft and camshaft and for adjusting the timing belt tension.

Installed in the following vehicles:

- ▶ Dacia Dokker, Duster, Logan, Lodgy, Sandero
- ▶ Jeep CJ5, Cherokee
- ▶ Lada Largus
- ▶ Mitsubishi Carisma, Space Star
- ▶ Nissan Kubistar, Primastar
- ▶ Opel Arena, Movano, Vivaro
- ▶ Renault Avantime, Clio, Espace, Fluence, Kangoo, Laguna, Megane, Modus, Rapid, Safrane, Scenic, Thalia, Twingo, R5, R9, R11, R19, R21, R25, Trafic, Master
- ▶ Suzuki Samurai



NEW PRODUCT

Engine codes: D7F, E5F, E7F, E7J, F1N, F3N, F3P, F3R, F4P, F4R, F7P, F7R, F8M, F8Q, F9Q, G8T, J5R, J7R, J8S, K4J, K4M, K7J, K7M, N7Q, N7U, N8, S8U, S9U, S9W

DESCRIPTION	ARTICLE	PRICE EUR*
Engine timing tool set, Renault	26387L	109,90
Locking tool camshafts	26387L-1	24,90
Locking tool crankshaft	26376L-5	5,90
Locking pin crankshaft	26387L-3	5,90
Locking tool crankshaft, ø 8 mm	26376L-6	4,20
Locking pin crankshaft	26387L-5	8,90
Adjusting tool tensioner	26387L-7	12,90
Adjusting tool tensioner	26387L-8	10,90
Locking tool camshafts	26387L-9	29,90
Locking pin crankshaft	26387L-10	6,90
Locking tool camshafts	26387L-6	25,90
Tensioning tool timing belt	26387L-11	13,90
Adjusting tool tensioner	26387L-4	16,90
Adjusting tool tensioner	26387L-2	10,90

ENGINE TIMING TOOL SET, RENAULT/OPEL/NISSAN

for locking the camshaft and crankshaft on 1.5, 1.9, 2.2 and 2.5 Renault Diesel engines

Installed in the following vehicles:

- ▶ Dacia Dokker, Duster, Logan, Lodgy, Sandero
- ▶ Mercedes A-Klasse W176, A-Klasse W177, B-Klasse W246, B-Klasse W247, CLA C117, CLA C118, GLA X156, Citan W415, Citan W420
- ▶ Nissan Almera, Cube, Juke, Kubistar, Micra, Note, Primera, Qashgai, Tiida, Interstar, Evalia, NV200, Primastar, NV250
- ▶ Opel Movano, Vivaro
- ▶ Renault Avantime, Captur, Clio, Espace, Fluence, Kadjar, Kangoo, Laguna, Megane, Modus, Scenic, Thalia, Twingo, Vel Satis, Trafic, Master
- ▶ Suzuki Grand Vitara, Jimny

Engine codes:

- ▶ Mercedes OM607, OM608
- ▶ Renault F9Q, G9M, G9T, G9U, K9K

Used equivalent to the following OE numbers:

- ▶ Crankshaft locking tool, ø 7 mm, Renault MOT-1536
- ▶ Locking tool intake Camshaft, Renault MOT-1534
- ▶ Locking tool exhaust camshaft, Renault MOT 1537
- ▶ Pump wheel locking tool, Renault MOT-1538
- ▶ Crankshaft locking tool, Renault MOT-1489
- ▶ Crankshaft locking tool, ø 8 mm, Renault MOT-1430
- ▶ Tensioning tool timing belt, Renault MOT-1543
- ▶ Locking pin high pressure pump, ø 3 mm
- ▶ Locking tool flywheel, Mercedes 607.589.01.40.00

Ideal addition to 26387L!



NEW PRODUCT

DESCRIPTION	ARTICLE	PRICE EUR*
Engine timing tool set, Renault/Opel/Nissan	26376L	109,90
Locking tool crankshaft, ø 7 mm	26376L-1	3,90
Locking tool intake camshaft	26376L-2	24,90
Locking tool exhaust camshaft	26376L-3	39,90
Locking tool pump sprocket	26376L-4	7,90
Locking tool crankshaft	26376L-5	5,90
Locking tool crankshaft, ø 8 mm	26376L-6	4,20
Tensioning tool timing belt	26376L-7	49,90
Locking pin high pressure pump, ø 3 mm	26376L-8	4,50
Locking tool flywheel	26377L	6,90

ENGINE TIMING TOOL SET, NISSAN/OPEL/RENAULT

for Common-Rail engines 1.5l + 1.9l + 2.2l + 2.5l from Renault, Opel, Nissan. Contains important tools for positioning and locking crankshaft and camshaft during toothed belt and engine repairs.

Engine codes: K9K, F9Q, G9T, G9U

IDEAL ADDITION TO 26058L!



DESCRIPTION	ARTICLE	PRICE EUR*
Engine timing tool set, Nissan/Opel/Renault	26048L	119,90

ENGINE ADJUSTMENT TOOL SET, FIAT/MERCEDES/NISSAN/OPEL/RENAULT

for professional engine repair for 1.6, 1.8 und 2.0 litre diesel engines.

Suitable for the following vehicles:

- ▶ Fiat Talento (296) 2016-
- ▶ Mercedes C-Klasse (205) 2014-2018, Vito/Metris (447) 2014-
- ▶ Nissan Qashqai (J10/J11) 2011-, X-Trail (T31/T32) 2007-, NV300 (X82) 2016-, Primastar (X83) 2006-
- ▶ Opel Vivaro (X82/X83) 2006-
- ▶ Renault Espace (JK0/JR) 2006-, Kadjar (HA/HL) 2015-, Koleos (HY/HC) 2008-, Laguna (BG0/KG0/BT0/KT0/DT0) 2006-, Latitude (L70) 2011-, Megane (BM0/BZ0/B9A) 2005-, Scénic and Grand Scénic (JM0/JZ0/J9) 2005-, Talisman (LP/KP) 2015-, Vel Satis (BJ0) 2005-, Trafic (JL/JG) 2006-

Engine Codes:

- ▶ M1D, M9R, R9M, OM622 und OM62

Die Nockenwellen- und Kurbelwellenarretierungen dürfen nicht als Gegenhalter zum Anziehen genutzt werden!



DESCRIPTION	ARTICLE	PRICE EUR*
Engine adjustment tool set, Fiat/Mercedes/Nissan/Opel/Renault	26009L	129,90

ENGINE ADJUSTMENT TOOL SET, ALFA ROMEO/FIAT

for locking and aligning the intake and exhaust camshafts e.g. when changing the timing belt.

- ▶ Incl. Special insert with 12.5 mm (1/2") drive for disassembling the phase adjuster
- ▶ 23 Precise locking tools for the intake and exhaust camshafts prevent the camshafts from rotating after installation and position them in the timing belt mounting position
- ▶ Locking tools are numbered and additionally marked in color to prevent any confusion
- ▶ With the OT point mandrel and a micrometer clock (not included), an accurate alignment of the crankshaft is possible

Suitable for following vehicles:

- ▶ Fiat Bravo 1.4 12V & 2.0 20V; Brava 1.4 12V & 2.0 20V Marea 2.0 20V; Coupe 1.8 16V; Barchetta 1.8 16V; Punto 1.8 16V
- ▶ Lancia K5 2.0 20V; 4 cyl. VIS engines from BJ. '96 Delta 1.8 16V Step A; Dedra 1.8 16V Step A; Y10 1.4 12V
- ▶ Alfa 145 + 146 1400 & 1600 16V Step A; 147 1600 16V Step A; 147 105 hp, 147 1600 eco 103PS; 155 1400 & 1600 16V Step A; 156 1600 16V Step A; 156 1800 - 2000 16V 156 2000 JTS; 166 2000; GTV 2000 JTS - Spider GT 2000 JTS 16V 165hp



DESCRIPTION	ARTICLE	PRICE EUR*
Engine adjustment tool set, Alfa Romeo/Fiat	26016L	184,90

ENGINE TIMING TOOL SET, FIAT/FORD/LANCIA

contains the most important tools for repair work on Alfa Romeo, Fiat, Ford and Lancia engines with 1.2 and 1.4 l. 8-valve petrol engines.

Suitable for the following vehicles:

- ▶ Alfa Romeo Mito '11-'18
- ▶ Fiat New 500 '07-, Doblo/Cargo '05-'10, Fiorino '08-, Qubo '09-, Grande Punto '07-'12, Idea '04-'12, Linea '07-'11, Panda '09-'12 und Grande Punto '05-'09, Punto Evo '09-'11, Punto '12-'18
- ▶ Ford Ka '09-'16
- ▶ Lancia Ypsilon '06-'17, Musa '05-'12

Engine codes:

- ▶ Alfa, Fiat, Lancia 169A4.000, 199A7.000, 350A1.000, 955A9.000
- ▶ Ford 169A4.000 (FP4)

Used equivalent to the following OE numbers:

- ▶ Locking tool crankshaft, Fiat 2.000.004.500, Ford 303-1480
- ▶ Adjusting tool camshafts, Fiat 2.000.004.400, Ford 303-1479
- ▶ Locking tool camshaft sprocket, Fiat 2.000.004.200, Ford 303-1477
- ▶ Locking tool camshaft, Fiat 2.000.004.300, Ford 303-1478
- ▶ Adjusting tool tensioner, Fiat 1.860.987.000



DESCRIPTION	ARTICLE	PRICE EUR*
Engine timing tool set, Fiat/Ford/Lancia	26358L	82,50
Adjusting tool tensioner	26358L-1	9,90
Locking tool crankshaft	26358L-2	12,90
Locking tool camshaft	26358L-3	39,90
Locking tool camshaft sprocket	26358L-4	14,90
Adjusting tool camshafts	26358L-5	10,90

ENGINE ADJUSTMENT TOOL SET, ALFA ROMEO/FIAT/LANCIA

for operations on the timing chain with 1.4 l MultiAir engines.

Suitable for the following vehicles:

- ▶ Alfa Romeo: Giulietta (2010-), MiTo (2008-2018)
- ▶ Fiat: Bravo II (2006-2014), Grande Punto (2005-2009), Punto Evo (2008-2012), Punto (2012-2018)
- ▶ Lancia: Delta III (2008-2014)

Engine codes: 198A7.000, 940A2.000, 955A2.000, 955A6.000, 955A7.000, 955A8.000, 955B1.000

Used equivalent to the following OE numbers:

- ▶ 2000034400
- ▶ 2000004500
- ▶ 1860987000

10-piece



DESCRIPTION	ARTICLE	PRICE EUR*
Engine adjustment tool set, Alfa Romeo/Fiat/Lancia	26194L	99,90
Camshaft setting tool	26194L-1	69,90
Adjusting tool tensioner	26358L-1	9,90
Locking tool crankshaft	26358L-2	12,90

ENGINE TIMING TOOL SET, FIAT

contains the most important tools for repair work on 2.3 and 2.8 l. Fiat and Iveco engines.

Suitable for the following vehicles:

- ▶ Fiat Ducato '01-'06, Ducato '06-
- ▶ Iveco Daily III '99-'06, Daily IV '06-'11, Daily V '11-'14, Daily VI '14-'19

Engine codes: 8140.43B, 8140.43C, 8140.43K, 8140.43R, F1AE0481A, F1AE0481B, F1AE0481C, F1AE0481D, F1AE0481F, F1AE0481G, F1AE0481H, F1AE0481M, F1AE0481N, F1AE0481R, F1AE0481U, F1AE0481V, F1AE3481A, F1AE3481B, F1AE3481C, F1AE3481D, F1AE3481E, F1AE3481G, F1AGL4111, F1AGL4112, F1AGL4113, F1AGL4114, F1AGL411A, F1AGL411B, F1AGL411C, F1AGL411D, F1AGL411G, F1AGL411H, F1AGL411J, F1AGL411M

Used equivalent to the following OE numbers:

- ▶ Locking tool camshafts, Fiat 99.360.614
- ▶ Locking pin crankshaft, Fiat 99.360.615
- ▶ Locking pin camshaft, Fiat 1.860.617.000
- ▶ Locking pin crankshaft, Fiat 2.000.018.200



DESCRIPTION	ARTICLE	PRICE EUR*
Engine timing tool set, Fiat	26359L	43,50
Locking tool camshafts	26359L-1	26,90
Locking pin crankshaft	26359L-2	12,90
Locking pin camshaft	26359L-3	8,90
Locking pin crankshaft	26359L-4	10,90

ENGINE ADJUSTMENT TOOL SET, HYUNDAI/KIA

includes the essential tools for installation and removal of camshaft wheels and chain wheels on high-pressure pumps, as well as for checking and setting the camshaft timing on current Hyundai and Kia models.

Suitable for the following vehicles:

- ▶ Kia Carens III (UN), Carens IV, Cee'd I (ED), Cee'd II (JD), Cerato I (LD), Optima (TF), Picanto I (BA), Rio III (UB), Rio IV (YB), Soul I (AM), Soul II (PS), Sportage III (SL), Sportage IV (QL), Venga (YN)
- ▶ Hyundai Accent (MC), Accent (RB), Elantra (HD), Getz (TB), i10 (PA), i20 (PB), i20 (GB), ix20 (JC), i30 (GD9), ix35 (LM), i40 (VF), Matrix (FC), Tucson (TLE)

Motor codes:

D3FA, D3FF, D4FA, D4FB, D4FB-H, D4FB-L, D4FC, D4FD, D4FD-H, D4FD-L

Used equivalent to the following OE numbers:

09331-2A000/ 09231-2A100



DESCRIPTION	ARTICLE	PRICE EUR*
Engine adjustment tool set, Hyundai/Kia	26178L	79,90
Pressure plate	26178L-1	84,90
Pressure spindle	26178L-2	37,90
Screw	26178L-3	3,90
Screw	26178L-4	4,90
Crankshaft locking tool	26178L-5	95,50
Locking pin	26178L-6	6,90

ENGINE ADJUSTMENT TOOL SET, VW/OPEL/FORD

for 4 and 6-cylinder engines from Opel and Ford as well as VAG, Saab, Citroën, Fiat, Peugeot, Rover, Isuzu and MG. Diesel and petrol engines.



DESCRIPTION	ARTICLE	PRICE EUR*
Engine adjustment tool set, VW/Opel/Ford	26035L	49,90
Locking tool Opel Ecotec 1,8+2,0 l	26095L	9,90
Locking tool Opel Ecotec 1,4 + 1,6 l	26096L	12,90
Locking tool Saab/Opel left	26097L	4,90
Locking tool Saab/Opel right	26098L	27,50
Locking tool flywheel	26377L	6,90
Locking tool crankshaft	26368L	11,90

LOCKING TOOL FLYWHEEL, HYUNDAI/KIA

The locking tool is fitted in place of the starter and locks the flywheel via the starter's ring gear. An indispensable tool when:

- ▶ Loosening the crankshaft bolt
- ▶ Changing the timing chain / timing belt

Suitable for:

- ▶ Hyundai Accent IV/V, Creta, Elantra IV/V/VI, Genesis, i10 I/II/III, i20 I/II/III, i30, i40, ix20, ix35, Kona, Santa Fé II/III/IV, Solaris, Sonata V/VI/VII, Tucson, Veloster
- ▶ Kia Carens III/IV, Cee'd, Cerato I/II/III/IV, Magentis II, Optima, Picanto II/III, Rio III/IV, Seltos, Sorento II/III, Soul I/II/III, Sportage III/IV, Stonic, Venga

Engine codes: D4FB, D4FC, D4FD, D4HA, D4HB, D4UU, G3LA, G3LC, G4FA, G4FC, G4FD, G4FG, G4FJ, G4KD, G4KE (nur Optima), G4KF, G4KH, G4KJ, G4LA, G4LC, G4LD, G4LK, G4NA, G4NC, G4ND, G4NE

Used equivalent to the following OE numbers::

- ▶ Kia 09231-2B100
- ▶ Kia 09231-3N100



NEW PRODUCT

DESCRIPTION	ARTICLE	PRICE EUR*
Locking tool flywheel, Hyundai/Kia	26325L	39,90

PULLER SET CAMSHAFT SPROCKETS

for removing 5- or 6-spoke camshaft sprockets. The different hook shapes allow almost unlimited use.
for Audi, Seat, Škoda and VW with 4-, 5-, 6- and 8-cylinder engines.

Für Motorcode: AAH, ABC, ACK, ACZ, AEJ, AFB, AGA, AGB, AGE, AGP, AGR, AHA, AHF, AJG, AJK, AKB, AKC, AKE, AKF, AKN, ALF, ALG, ALH, ALW, AML, AMM, AMX, ANK, APB, APC, APR, APS, APZ, AQD, AQF, AQG, AQH, AQJ, AQM, ARE, ARJ, ARN, ARS, ART, ARU, ASG, ASJ, ASM, ASV, ASY, ATQ, ATX, AUW, AUX, AVB, AVF, AVN, AVP, AWA, AWN, AWX, AXQ, AXW, AXX, AYM, AYQ, AYS, AZA, AZB, AZR, AZV, BAU, BBD, BBG, BCS, BCY, BCZ, BDG, BDH, BDV, BEL, BES, BFC, BFL, BFM, BGB, BGH, BGJ, BGK, BGW, BHD, BHW, BHX, BHZ, BJJ, BJK, BJL, BKD, BKE, BKP, BLB, BLR, BLX, BLY, BMA, BMB, BMN, BMP, BMR, BNA, BPG, BPJ, BPW, BPY, BRB, BRC, BRD, BRE, BRF, BRV, BUL, BUZ, BVA, BVE, BVF, BVG, BVX, BVY, BVZ, BWA, BWE, BWJ, BWT, BWV, BYD, BYK, BZC, CCGA, CDLA, CDLB, CDLC, CDLD, CDLF, CDLG, CDLH, CDLJ, CDLK, CDMA, CEBA, CEBB, CECA, CECB, CRZA

Used equivalent to the following OE numbers:

- ▶ VAG T40001



DESCRIPTION	ARTICLE	PRICE EUR*
Puller set camshaft sprockets	26351L	69,90

CAMSHAFT FIXING TOOL

Is required for changing toothed belts and all jobs related to engine timing

- ▶ Can be used for all DOHC diesel and petrol engines
- ▶ Fixing by camshafts being mutually supported
- ▶ Fixing pins made of hardened steel, leading to long service life
- ▶ Suitable for universal use thanks to two central arms of different lengths
- ▶ Special locking handle for the central arm bolts can be turned to a space-saving position



NICHT FÜR OHC MOTOREN GEEIGNET

DESCRIPTION	ARTICLE	PRICE EUR*
Camshaft fixing tool	26018L	59,90

CAMSHAFT STEADY

adjustable from 40 - 220 mm

Thanks to the design length of about 500 mm and the force application connected with this, ideal for loosening the attachment screw on injection pumps and for steadying the toothed belt sprocket on the camshaft etc.

- ▶ incl. 4 pairs of inserts Ø 6 - 10, 8 - 11, 10 - 12, 11 - 16 mm, to be used with nearly every camshaft gear wheels



DESCRIPTION	ARTICLE	PRICE EUR*
Camshaft steady	10577L	59,90
Camshaft counterholder	10577L-1	58,00
Insert	10577L-2	7,50
Insert	10577L-3	7,50
Insert	10577L-4	8,50
Insert	10577L-5	11,50
Screw	10577L-6	3,50

MUFFLER WEDGE SET

for mounting clamping springs on the manifold of different VAG mufflers



DESCRIPTION	ARTICLE	PRICE EUR*
Muffler wedge set	26010L	9,90

FUEL INJECTION PUMP TOOL, BMW

for dismantling and assembling the pump shaft on BMW Common-Rail diesel engines M47, M47TU, M57, M57TU.

- ▶ 7-Series '94 - '01 (E38)
- ▶ 5-Series '95 - '03 (E39)
- ▶ 5-Series from model year '03 (E60) + Touring (E61)
- ▶ 3-Series '98 - '07 (E46)
- ▶ X5 '99 - '06 (E53)



DESCRIPTION	ARTICLE	PRICE EUR*
Fuel injection pump tool, BMW	26034L	23,90

MOUNTING LEVER DSG GEARBOX, VW

for assembly and disassembly of mechatronics in 7-speed dual-clutch transmissions 0 AM/OCG/OCW.

Installed in the following vehicles:

- ▶ Audi A1 (2010-2018), A3 (2004-2015), A3 (2012-), Q2 (2016-), TT (2006-2015), TT (2014-)
- ▶ Seat Altea (2009-), Ateca (2016-), Ibiza (2008-2017), Ibiza (2016-), Leon (2005-2013), Leon (2012-), Toledo (2012-)
- ▶ Skoda Fabia (2006-2014), Fabia (2014-), Octavia (2004-2013), Octavia (2012-), Rapid (2012-), Roomster (2006-2015), Superb (2008-2015), Yeti (2009-2017)
- ▶ VW Beetle (2011-), Caddy (2004-2015), Caddy (2015-), CC (2011-2016), Eos (2006-2015), Golf (2003-2009), Golf (2008-2013), Golf (2013-), Jetta (2004-2010), Jetta (2009-), Passat (2005-2011), Passat (2010-2014), Passat (2014-), Polo (2010-), Scirocco (2008-2017), Touran (2003-2010), Touran (2015-), XL1 (2014-)

Used equivalent to OE number T10407.



DESCRIPTION	ARTICLE	PRICE EUR*
Mounting lever DSG gearbox, VW	26303L	19,90

**NEW
PRODUCT**

VAG ENGINE ADJUSTMENT TOOL SET

Very comprehensive universal set for vehicles with VAG petrol and diesel engines. Includes tools for locking the flywheel, crankshaft and camshaft as well as for adjusting the timing belt tension.

Installed in the following vehicles:

- ▶ Audi A1, A2, A3, A4, A5, A6, A8, Q3, Q5, TT, Coupe, Cabriolet, 80, 100
- ▶ Ford Galaxy
- ▶ Mitsubishi Lancer
- ▶ Seat Alhambra, Altea, Arosa, Cordoba, Exeo, Ibiza, Inca, Leon, Toledo
- ▶ Skoda Fabia, Felicia, Octavia, Rapid, Roomster, Superb, Yeti
- ▶ VW Amarok, Beetle, Bora, Caddy, Eos, Fox, Golf, Jetta, Lupo, Passat, Polo, Scirocco, Sharan, Tiguan, Touran, Vento, LT, Transporter

ART. 26383L

149,90*€



MORE INFO
ON PAGE 12