

2024

www.swstahl.de

TOOLNEWS

FOR PROFESSIONALS



DESIGNED
IN GERMANY

THE NEW GENERATION IMPACT WRENCHES

4

Awards
for the
TT Edition

8

The new
generation of
impact wrenches

14

Professional
engine timing
tool set

SW STAHL
PROFESSIONAL TOOLS



3 QUESTIONS TO...

INTERVIEW

WITH MARCEL HEINEMANN
SALES MANAGER SW STAHL

1

2023 SW STAHL HAS WON OVER SEVERAL PRESTIGIOUS DESIGN JURIES. CAN YOU GIVE US SOME DETAILS?

Marcel Heinemann: We are very proud to announce that our TT Workshop Trolley Edition has won two major design awards. One was the German Design Award 2023 and the other was the Red Dot Award 2023, with our Idealline also winning over the Red Dot jury. For us, these design awards are confirmation that we are on the right track with our products and that we will continue on this path in 2024. Something to look forward to.

2

WILL IT BE POSSIBLE TO SEE SW STAHL LIVE AGAIN IN 2024?

Marcel Heinemann: We are going full throttle for 2024. We will be at a wide range of trade shows and roadshows. Because you have to see, feel, test and, of course, fall in love with our range of tools. Our highly motivated team will do everything in their power to make our tools the ultimate experience at our live events. Just come along and be inspired.

3

WHAT ELSE CAN WE LOOK FORWARD TO IN 2024?

Marcel Heinemann: In order to give our customers a complete picture of our current and extensive product range, our Toolbook will be launched in 2024. All our products are explained in detail in this product catalogue and are easy to find thanks to a clever category and index system. An absolute must for every workshop!

MR HEINEMANN, THANK YOU VERY MUCH FOR THIS INTERVIEW.

Marcel Heinemann: Gladly..

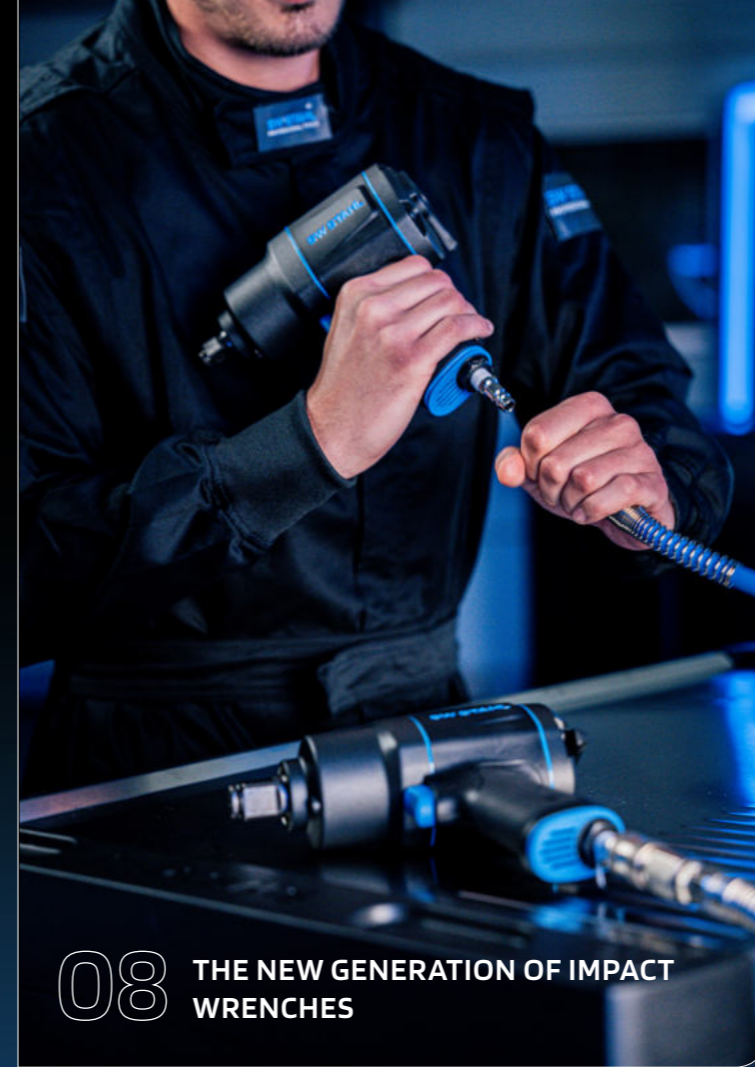

08 THE NEW GENERATION OF IMPACT WRENCHES



04 THE TT EDITION GOES ONE STEP FURTHER



14 OUR NEW PROFESSIONAL ENGINE TIMING TOOL SET

CONTENT

- 4 | Our TT Edition has won
- 8 | The new generation of impact wrenches
- 14 | The new engine timing tool sets

- C A T E G O R I E S
- Spanners
 - Sockets / Accessories
 - Bit inserts
 - Screwing tools
 - Pliers
 - Puller
 - General Hand Tools
 - Pneumatic tools
 - Electric / Battery Tools
 - Torque tools
 - Diagnostic / test equipment
 - Motor
 - Transmission/Clutch
 - Exhaust system
 - Air conditioner
 - Chassis/Axles
 - Wheels / Tyres
 - Brakes
 - Car body
 - Vehicle electrics
 - Workshop trolley / modular inserts
 - Tool assortments
 - Workshop equipment
 - Workshop supplies
 - Motorbike
 - Commercial vehicles

HOTLINE TECHNICAL SERVICE
+49 (0) 21 91 / 464 38 -55

SW STAHL COMMERCIAL SERVICE
PROFESSIONAL TOOLS +49 (0) 21 91 / 464 38 -45

WITH HIGH-PERFORMANCE INTO THE TOP CLASS

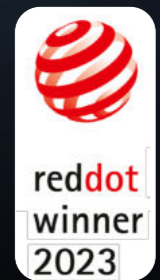

THE TT800 EDITION HAS CONVINCED THE JURIES AND WON!

2023 was a more than successful year for our TT Edition workshop trolleys. Not only were our customers impressed by the functionality, design, workmanship and exclusive interior of the TT801 and TT802 models, but the two juries of the most prestigious design awards, the German Design Award and the Red Dot Award, were also completely convinced by our workshop trolleys and honoured them with their respective design awards.

WE ARE VERY PROUD AND EXCITED TO BE REVOLUTIONISING THE
WORKSHOPS WITH OUR TT EDITION.



YOUR WORKSHOP DNA THE WINNERS ARE...

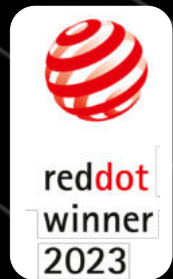

WE HAVE WON!

IT WASN'T JUST OUR TT EDITION WORKSHOP TROLLEY THAT WON OVER THE RED DOT DESIGN JURY, BUT ALSO OUR IDEAL RANGE OF TOOLS. POWERFUL TOOLS THAT MAKE YOUR WORK EASIER, READY FOR ANY JOB AND WITH A HANDLE THAT SITS SO WELL IN YOUR HAND THAT YOU WON'T WANT TO PUT THEM DOWN. THE BEST MATERIALS ARE USED TO MAKE EACH TOOL LAST A LONG TIME. A SPECIAL HIGHLIGHT IS OUR HIGH TORQUE REVERSIBLE RATCHET WITH AN UNBEATABLE TORQUE OF 1,075 NM. THE MOST POWERFUL REVERSIBLE RATCHET FROM SW STAHL THAT NO TRADESMAN SHOULD BE WITHOUT.



READY FOR BOOST

THE NEW GENERATION IMPACT WRENCHES



IMMERSE YOURSELF
IN THE WORLD OF
NEW GENERATION
IMPACT WRENCHES

YOU NEED TO BE ABLE TO RELY ON THEM WHEN THE CHIPS ARE DOWN. OUR NEW IMPACT WRENCHES ARE ALWAYS READY FOR USE AND YOUR PERFECT PARTNER WHEN IT COMES TO CHANGING TYRES.

STRONG, BEAUTIFUL AND EVERYWHERE
WITH EXTREME PRESSURE.

DESIGNED IN
GERMANY

⊗ PRESSURE RUN MOTOR

ONE-HANDED SWITCHING ⊗

⊗ HIGH-PERFORMANCE DOUBLE HAMMER IMPACT MECHANISM

⊗ HANDLE WITH SPECIAL TEXTURE

FOR 1/2" & 3/4"

TIGHTENING TORQUE: 750 NM - 1,300 NM ⊗
LOOSENING TORQUE: 1,300 NM - 1,900 NM

INNER VALUES

OUR NEW IMPACT WRENCH SERIES - WELL THOUGHT-OUT!

WE ARE YOUR PROFESSIONAL PARTNER
FOR AUTOMOTIVE TOOLS.

OUR NEW ENGINE TIMING TOOL SETS!

To make your work even more professional, we have completely redesigned some of our engine timing tools.

Engine timing tools are the heart of every workshop and the secret of perfect performance in the automotive industry. They are not only important, they are essential to ensure the precision and efficiency of engines.

SW STAHL's brand new designer case for engine timing tools not only stores your tools neatly and safely, it also looks great in your workshop.

Our engine timing tools are designed for durability and reliability. Made from heavy-duty steel, they can withstand the rigours of everyday workshop use and give you years of service.

The tools are not only robust, but also easy to use, which extends the life of the tool. Accuracy of fit is another key benefit of these tools. Our engine alignment tools are optimised for the elements of many engine models. This enables accurate and precise alignment, which has a direct impact on engine performance and efficiency.

We have developed a comprehensive range of tools for a wide variety of vehicle models from leading brands such as Audi, Seat, Skoda, VW to Opel, Fiat, Iveco and many more. Whether it's cam and crankshaft tensioners or camshaft sprocket extractors, we have the right engine timing tool for your workshop. Our new generation of engine timing tools will take your work to a whole new level and give you the confidence that you are ready for any challenge in the automotive industry.



tool-is

OUR TOOL DATABASE

www.tool-is.com
HAVE A LOOK AND SEE FOR YOURSELF!

WE HAVE YOUR TOOLS.



Stop playing hide-and-seek: there's nothing worse than needing a tool and not being able to find it, or only remembering it vaguely. We know this. That's why we invented TOOL-IS: SW Stahl's online tool search engine.



From now on TOOL-IS can do even more. Or rather: you can do even more. You can now use TOOL-IS on mobile devices (smartphones or tablets). Availability, promotions and prices are displayed in real time - it couldn't be faster or more up-to-date. What's more, thanks to the various search options, you're sure to find what you're looking for, even if you only have a few points to look at.

LOGIN NOW TO SEE
MORE CONTENT!

- ⊗ FAST AND FLEXIBLE ONLINE TOOL SEARCH
- ⊗ REAL-TIME DISPLAY OF AVAILABILITY, PROMOTIONS, PRICES AND MORE
- ⊗ CAN ALSO BE USED ON SMARTPHONES AND TABLETS
- ⊗ QUICK SEARCH WITH AUTOMATIC SEARCH SUGGESTIONS
- ⊗ KEYWORD AND FULL TEXT SEARCH
- ⊗ SEARCH FOR OE NUMBERS, ENGINE CODES, ARTICLE NUMBERS OR VEHICLE TYPES
- ⊗ GERMAN, ENGLISH AND FRENCH
- ⊗ CREATE WATCH LISTS



**DOUBLE OPEN-ENDED SPANNER SET,
6-22 MM, 8-PIECE**

- ▶ Spanner heads angled by 15°
 - ▶ Packed in practical plastic tube with EURO-hanger
- 6 x 7 mm, 8 x 9 mm, 10 x 11 mm, 12 x 13 mm,
14 x 15 mm, 16 x 17 mm, 18 x 19 mm, 21 x 22 mm



00150L 18,20 EUR*

**DOUBLE OPEN-ENDED SPANNER SET,
6-32 MM, 10-PIECE**

- ▶ Spanner heads inclined by 15°
 - ▶ Packed in practical roll-up bag
- 6, 7, 8, 9, 10, 11, 12, 13, 14, 15, 16, 17, 18, 19, 21, 22,
24, 27, 30, 32 mm



00151L 44,90 EUR*

**COMBINATION SPANNER SET, 8-19 MM,
8-PIECE**

Chromium vanadium, matt chrome-plated.



01-121-WB 15,90 EUR*

**COMBINATION SPANNER SET, 6-22 MM,
CRANKED, 15-PIECE**

- ▶ Ring head 10° cranked
 - ▶ Clevis angled by 15°
 - ▶ Packed in practical plastic tube with EURO-hanger
- 6, 7, 8, 9, 10, 11, 12, 13, 14, 15, 16, 17, 18, 19, 22 mm



00192L 59,90 EUR*

**DOUBLE OPEN-ENDED SPANNER SET,
6-22 MM, 8-PIECE**

- ▶ Chromium vanadium, matt chrome-plated
- ▶ Double open-ended, in display box



01-110-WB 19,90 EUR*

**COMBINATION SPANNER SET, 6-22 MM,
15-PIECE**

- ▶ The clevis and ring head are angled by 15°
 - ▶ Packed in practical plastic tube with EURO-hanger
- 6, 7, 8, 9, 10, 11, 12, 13, 14, 15, 16, 17, 18, 19, 22 mm



00162L 39,90 EUR*

**COMBINATION SPANNER SET, 10-32 MM,
CRANKED, 16-PIECE**

- ▶ Ring head 10° cranked
 - ▶ Clevis angled by 15°
 - ▶ Packed in practical roll-up bag
- 10, 11, 12, 13, 14, 15, 16, 17, 18, 19, 21, 22, 24,
27, 30, 32 mm

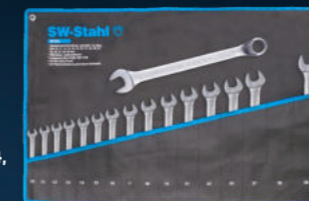

00193L 89,90 EUR*

**DOUBLE-RING SPANNER SET, E-PROFILE,
E6-E24, 6-PIECE**

- ▶ With flat shape for special E-profile screws
- ▶ Chrom-vanadium, matt chrome-plated



01560L 64,90 EUR*

**COMBINATION SPANNER SET, 10-32 MM,
16-PIECE**

- ▶ The clevis and ring head are angled by 15°
 - ▶ Packed in practical roll-up bag
- 10, 11, 12, 13, 14, 15, 16, 17, 18, 19, 21, 22, 24,
27, 30, 32 mm



00163L 79,90 EUR*

**COMBINATION SPANNER SET, 1/4"-3/4",
8-PIECE**

- ▶ The clevis and ring head are angled by 15°
 - ▶ Packed in practical plastic tube with EURO-hanger
- 1/4, 5/16, 3/8, 7/16, 1/2, 9/16, 5/8, 3/4"



00166L 34,90 EUR*

**DOUBLE-RING SPANNER SET, 6-22 MM,
CRANKED, 8-PIECE**

- ▶ With deep cranked ring heads
 - ▶ Packed in practical plastic tube with EURO-hanger
- 6 x 7, 8 x 9, 10 x 11, 12 x 13, 14 x 15, 16 x 17, 18 x 19,
20 x 22 mm



00180L 25,90 EUR*

**DOUBLE-RING SPANNER SET, 6-32 MM,
CRANKED, 11-PIECE**

- ▶ With deep cranked ring heads
 - ▶ Packed in practical roll-up bag
- 6 x 7, 8 x 9, 10 x 11, 12 x 13, 14 x 15, 16 x 17,
18 x 19, 20 x 22, 21 x 23, 24 x 27, 30 x 32 mm



00181L 49,90 EUR*

**COMBINATION SPANNER SET, 10 - 19 MM,
EXTRA SHORT, 10-PIECE**

Chromium vanadium, extra short, glare-free.
For tight swivelling angles and spots that are difficult to access, e.g. on air-conditioning systems, instruments, during radio installation, in the door and engine area.
Length between 90 and 140 mm.



00840L 38,90 EUR*

**COMBINATION SPANNER SET, 21-32 MM,
EXTRA LONG, 6-PIECE**

- Chromium vanadium, chrome-plated, matt chrome-plated, finely polished, in black roll-up pouch.
- ▶ Extra long version enables high power transmission
 - ▶ Hardness and torque exceed the requirements of the relevant DIN standards
- ▶ 21, 22, 24, 27, 30, 32 mm



00835L 79,90 EUR*

**DOUBLE-RING SPANNER SET, 6-22 MM,
CRANKED, 8-PIECE**

- ▶ Chromium vanadium, matt chrome-plated
- ▶ Double cropped, in display box



01-141-WB 28,90 EUR*

**DOUBLE-RING SPANNER SET, E-PROFILE,
E6-E24, CRANKED, 6-PIECE**

- Chromium vanadium, matt chrome-plated, double cropped.
- ▶ E6 x E8
 - ▶ E7 x E11
 - ▶ E10 x E12
 - ▶ E14 x E18
 - ▶ E16 x E22
 - ▶ E20 x E24



01580L 74,90 EUR*

RING RATCHET SPANNER, 4-IN-1

Combined spanner with 4 sizes: 10 - 13 - 17 - 19 mm

- ▶ Chrome vanadium, straight
- ▶ Finely toothed with 72 teeth
- ▶ Reversible
- ▶ Slim ratchet head
- ▶ Length: 200 mm
- ▶ Height: 15 mm



HERE IT GOES
TO THE VIDEO



03580L 19,90 EUR*

COMBINATION RATCHET SPANNER SET, 8-19 MM, 12-PIECE

- ▶ Sizes: 8 - 19 mm
- ▶ Made of high quality chrome-vanadium, satin finish
- ▶ In practical storage bag
- ▶ Finely toothed with 72 teeth



HERE IT GOES
TO THE VIDEO



03510L 122,50 EUR*

COMBINATION RATCHET SPANNER SET, 8-19 MM, REVERSIBLE, 12-PIECE

- ▶ Reversible
- ▶ Sizes: 8 - 19 mm
- ▶ Made of high quality chrome-vanadium, satin finish
- ▶ In practical storage bag
- ▶ Finely toothed with 72 teeth



HERE IT GOES
TO THE VIDEO



03520L 137,90 EUR*

COMBINATION RATCHET WRENCH SET, MULTI-PROFILE, 8-19 MM, 7-PIECE

- ▶ Chrome-vanadium, matt chrome-plated
- ▶ With 72 teeth
- ▶ Ring side in multi-profile - suitable for metric, inch, hexagon, double-hexagon and E-profile screws



S1594 76,55 EUR*

COMBINATION RATCHET SPANNER SET, 8-19 MM, WITH JOINT, 12-PIECE

- ▶ With continuously variable swivel head
- ▶ Sizes: 8 - 19 mm
- ▶ Made of high-quality satin-finish chrome vanadium
- ▶ Supplied in a practical storage pouch
- ▶ 72 teeth



HERE IT GOES
TO THE VIDEO



03530L 139,90 EUR*

COMBINATION RATCHET SPANNER SET, 8-19 MM, WITH JOINT, SHORT, 12-PIECE

- ▶ For working in confined spaces
- ▶ With stepless joint
- ▶ Sizes: 8 - 19 mm
- ▶ Made of high quality chrome-vanadium, matt
- ▶ Finely toothed with 72 teeth
- ▶ In practical storage bag



03540L 107,90 EUR*

DOUBLE RING RATCHET SPANNER SET, 12-19 MM, EXTRA LONG, 6-PIECE

- ▶ For hard to reach places e.g. for timing belt repairs
 - ▶ With ratchet function, load capacity 50% above DIN requirement
- Sizes:
- ▶ 12 x 328 mm, 13 x 367 mm, 16 x 390 mm, 17 x 406 mm, 18 x 419 mm, 19 x 430 mm



03590L 84,90 EUR*

S-TYPE DOUBLE-RING SPANNER SET, 10-19 MM, 5-PIECE

- ▶ Chromium vanadium, chrome plated
- ▶ Ideal for hard to reach places
- ▶ Bihexagonal
- ▶ In roll bag



01905L 34,90 EUR*

CONCENTRATED POWER IN THE HEAD!

DESIGNED
IN GERMANY



reddot winner 2023



DESIGN
AWARD
2019

RATCHET WRENCH SET, 1/2" AND 1/4", SLIM DESIGN, 2-PIECE

The new, particularly slim design of the reversible ratchet makes it easy to work in confined spaces.

- ▶ Especially slim shape
- ▶ Fine toothed with 72 teeth
- ▶ Drive: 12.5 mm (1/2") / 6.3 mm (1/4")
- ▶ High torque - 50% above DIN
- ▶ Material: chromium vanadium
- ▶ With insert lock
- ▶ Particularly handy 2-component handle



reddot winner 2023



DESIGN
AWARD
2019

06026L 49,90 EUR*

RATCHET WRENCH SET, 1/4" AND 1/2", HIGH TORQUE, 2-PIECE

Due to a particularly high torque, the reversible ratchets are the perfect tool for example to remove stubborn and stuck screws.

- ▶ Fine toothed with 90 teeth
- ▶ Very low swing angle
- ▶ Material: chrome vanadium
- ▶ Particularly handy 2-component handle
- ▶ Tested by an independent testing institute

Content:

- ▶ 1/2" ratchet wrench 06092L, 1,075 Nm
- ▶ 1/4" ratchet wrench 06094L, 135 Nm



reddot winner 2023



DESIGN
AWARD
2019

06096L 78,60 EUR*

RATCHET WRENCH, 1/4", HIGH TORQUE, 135 NM

Due to a particularly high torque, the reversible ratchet is the perfect tool for example for loosening stubborn and stuck screws.

- ▶ Drive: 6.3 mm (1/4")
- ▶ Particularly high torque: 135 Nm
- ▶ Fine toothed with 90 teeth
- ▶ Very low swing angle
- ▶ Material: chromium vanadium
- ▶ Particularly handy 2-component handle
- ▶ Tested by an independent testing institute



reddot winner 2023



DESIGN
AWARD
2019



MAXIMUM TORQUE IN NM

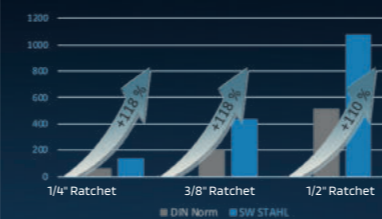

HERE IT GOES
TO THE VIDEO



06094L 31,40 EUR*

RATCHET WRENCH, 3/8", HIGH TORQUE, 440 NM

Due to a particularly high torque, the reversible ratchet is the perfect tool for example for loosening stubborn and stuck screws.

- ▶ Drive: 10 mm (3/8")
- ▶ Particularly high torque: 440 Nm
- ▶ Fine toothed with 90 teeth
- ▶ Very low swing angle
- ▶ Material: chromium vanadium
- ▶ Particularly handy 2-component handle
- ▶ Tested by an independent testing institute



reddot winner 2023



DESIGN
AWARD
2019



MAXIMUM TORQUE IN NM

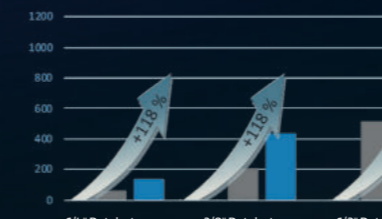

HERE IT GOES
TO THE VIDEO



06093L 39,80 EUR*

RATCHET WRENCH, 1/2", HIGH TORQUE, 1,075 NM

Due to a particularly high torque, the reversible ratchet is the perfect tool for example for loosening stubborn and stuck screws.

- ▶ Drive: 12.5 mm (1/2")
- ▶ Particularly high torque: 1,075 Nm
- ▶ Fine toothed with 90 teeth
- ▶ Very low swing angle
- ▶ Material: chromium vanadium
- ▶ Particularly handy 2-component handle
- ▶ Tested by an independent testing institute



reddot winner 2023



DESIGN
AWARD
2019



110% INCREASED PERFORMANCE

1.075 NM

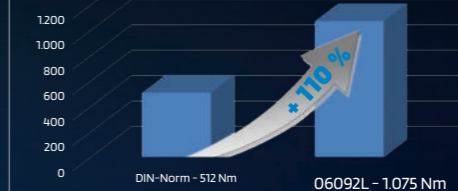

06092L 47,20 EUR*

RATCHET WRENCH, 3/8", SLIM DESIGN

The new, particularly slim design of the reversible ratchet makes it easy to work in confined spaces.

- ▶ Especially slim shape
- ▶ Fine toothed with 72 teeth
- ▶ Drive: 10 mm (3/8")
- ▶ High torque - 50% above DIN
- ▶ Material: chromium vanadium
- ▶ With insert lock
- ▶ Particularly handy 2-component handle



DESIGN
AWARD
2019



reddot winner 2023



06038L 26,10 EUR*

RATCHET WRENCH, 1/4", SLIM DESIGN

The new, particularly slim design of the reversible ratchet makes it easy to work in confined spaces.

- ▶ Especially slim shape
- ▶ Fine toothed with 72 teeth
- ▶ Drive: 6.3 mm (1/4")
- ▶ High torque - 50% above DIN
- ▶ Material: chromium vanadium
- ▶ With insert lock
- ▶ Particularly handy 2-component handle



red dot winner 2023

06014L 20,90 EUR*

RATCHET WRENCH, 1/2", SLIM DESIGN

The new, particularly slim design of the reversible ratchet makes it easy to work in confined spaces.

- ▶ Especially slim shape
- ▶ Fine toothed with 72 teeth
- ▶ Drive: 12.5 mm (1/2")
- ▶ High torque - 50% above DIN
- ▶ Material: chromium vanadium
- ▶ With insert lock
- ▶ Particularly handy 2-component handle



red dot winner 2023

HERE IT GOES
TO THE VIDEO



06012L 32,90 EUR*

RATCHET WRENCH, 1/2", HIGH TORQUE, 1,075 NM, TELESCOPIC

The particularly high torque of the ratchet wrench in combination with a telescopic extension is the perfect tool for loosening stubborn and stuck screws.

- ▶ Drive: 12.5 mm (1/2")
- ▶ Particularly high torque: 1,075 Nm
- ▶ With telescopic extension
- ▶ Can be fixed in 6 positions at 310 - 340 - 365 - 390 - 420 - 450 mm
- ▶ Fine toothed with 90 teeth
- ▶ Particularly handy 2-component handle

DESIGNED
IN GERMANY



red dot winner 2023



450 CM
420 CM
390 CM
365 CM
340 CM
310 CM

06090L 88,10 EUR*

EXTENSION SET, 1/2", 3-PIECE

- ▶ Chromium vanadium, chrome-plated
- ▶ For covering large distances

Sizes:

- ▶ 450 - 600 - 750 mm



05920L 40,00 EUR*

SPANNER SOCKETS, 1/2", DOUBLE HEXAGON, 10-24 MM, DEEP, 13-PIECE

Chromium vanadium, chrome-plated.

Sizes:

- ▶ 10 - 11 - 12 - 13 - 14 - 15 - 16 - 17 - 18 - 19 - 21 - 22 - 24 mm



05632L 34,90 EUR*

SPANNER SOCKETS, 1/2", EP PROFILE, EP18-EP32, 8-PIECE

12.5 mm (1/2") drive, chromium vanadium steel, matt chrome.

- ▶ EP18 - EP20 - EP22 - EP24 - EP26 - EP28 - EP30 - EP32
- ▶ With metal bracket



04432L 79,90 EUR*

SCREWDRIVER BITS, 1/2", SPLINE 1/2", M6-M12, 6-PIECE

- ▶ 6-piece set
- ▶ Chromium vanadium
- ▶ Pressed tightly to the socket
- ▶ In box with moulded insert



S5106 28,90 EUR*

IMPACT SPANNER SOCKETS, 1/2", DOUBLE HEXAGON, 8-PIECE

high-strength, for loosening the propeller shaft screws on different vehicles, e.g. Audi, BMW, Citroën, Ford, Opel, Mercedes-Benz, Nissan Skoda, Seat, Renault, VW etc.

Comprising:

- ▶ 5 extremely deep double-hexagon sockets: 27 - 30 - 32 - 34 - 36 mm
- ▶ 3 Inner hex sockets 14 - 17 - 19 mm



10185L 79,90 EUR*

SOCKET SET, 1/2", MULTI-PROFILE, 8-32 MM, 19-PIECE

Chromium vanadium, suitable for E-profile, inch, metric, hexagon & double-hexagon.

- ▶ 8, 9, 10, 11, 12, 13, 14, 15, 16, 17, 18, 19, 20, 21, 22, 24, 27, 30, 32 mm



05650L 41,90 EUR*

SCREWDRIVER BITS, 1/2", SPLINE, M5-M16, 26-PIECE

12.5 mm (1/2") drive, chromium vanadium S2-special steel

- ▶ 55 mm long M5 - M6 - M8 - M9 - M10 - M12 - M14 - M16
- ▶ 100 mm long M5 - M6 - M8 - M9 - M10 - M12 - M14
- ▶ 140 mm long M5 - M6 - M8 - M9 - M10 - M12 - M14
- ▶ 200 mm long M8 - M10 - M12 - M14



04424L 79,90 EUR*

SOCKET SPANNER SET, 3/4", 21-PIECE

- ▶ Reversible ratchet, 500 mm
- ▶ Extensions: 100 - 200 - 400 mm
- ▶ Sliding handle 450 mm
- ▶ Hexagonal bits 19 - 21 - 22 - 23 - 24 - 26 - 27 - 29 - 30 - 32 - 34 - 36 - 38 - 41 - 46 - 50 mm



07660L 219,90 EUR*

SOCKET SPANNER SET, 1/2", LOW PROFILE, 24-PIECE

low profile / extra flat sockets

- ▶ ideal for confined spaces
- ▶ up to 50% space saving due to low profile

Torque and hardness according to DIN, 12.5 mm (1/2") drive, chrome vanadium, hexagonal inserts for maximum torque

- ▶ 1 each hexagon low profile socket 8, 9, 10, 11, 12, 13, 14, 15, 16, 17, 18, 19, 20, 21, 22, 24, 27, 30, 32 mm
- ▶ Reversible ratchet wrench, 72 teeth
- ▶ 1 extension each 125 mm, 250 mm
- ▶ Cardan joint
- ▶ Adapter for sockets, 1/2"



07625L 179,90 EUR*

SOCKET SPANNER SET, 1/4", LOW PROFILE, 25-PIECE

low profile / extra flat sockets

- ▶ ideal for confined spaces
- ▶ up to 50% space saving due to low profile

Torque and hardness according to DIN, 6.3 mm (1/4") drive, chrome vanadium, hexagonal inserts for maximum torque

- ▶ 1 each hexagon low profile socket 4, 4.5, 5, 5.5, 6, 7, 8, 9, 10, 11, 12, 13, 14 mm
- ▶ 1 each bit, cross slot PH1, PH2
- ▶ 1 each bit, plain slot 4, 5, 6 mm
- ▶ 1 each bit, T-profile without tamperproof T10, T15, T20, T25, T30
- ▶ Reversible ratchet wrench, 72 teeth
- ▶ Bit adapter low profile, 1/4"



06425L 64,90 EUR*



INDUSTRIAL SOCKET SPANNER SET, 3/8", 34-PIECE

10 mm (3/8") drive, chrome-vanadium steel, hexagon sockets for maximum torque.

- ▶ Lever-type reversible ratchet wrench with quick-release feature for sockets
- ▶ Hexagon sockets 6-7-8-9-10-11-12-13-15-17-19-22-24
- ▶ Spark plug sockets size 16 + 21
- ▶ T-profile, tamperproof T15-20-25-27-30-40
- ▶ Inner hexagon 5 - 6 - 7 - 8 - 10
- ▶ XZN 8 - 10 - 12
- ▶ 2 extensions
- ▶ Cardan joint
- ▶ Sliding handle



06520L 64,90 EUR*

INDUSTRIAL SCREWDRIVER SET, 3/8", 34-PIECE

Chromium vanadium, bit inserts firmly pressed with the socket.

- ▶ Screwdriver bits T10 - 15 - 20 - 25 - 27 - 30 - 40 - 45 - 50 - 55 - 60
- ▶ Spanner sockets E4 - 6 - 8 - 10 - 12 - 14 - 16 - 18 - 20
- ▶ Bits T10 - 15 - 20 - 25 - 27 - 30 - 40 - 50 - 55 x 8 mm
- ▶ 1 bit adapter



04187L 46,90 EUR*

SOCKET SET, 1/4"+1/2", 4-32 MM, 28-TEILIG

with rust-protected surface 6.3 mm (1/4") + 12.5 mm (1/2"). Ideal for flat screw heads and nuts where conventional sockets slip and become damaged.

- ▶ 6.3 mm (1/4") drive 4, 5, 6, 7, 8, 9, 10, 11, 12, 13, 14 mm
- ▶ 12.5 mm (1/2") drive 10, 11, 12, 13, 14, 15, 16, 17, 18, 19, 20, 21, 22, 24, 27, 30, 32 mm



05655L 75,90 EUR*

SOCKET SPANNER SET, 3/8", 8-19 MM, DEEP, 11-PIECE

Deep spanner sockets, chromium vanadium, 10 mm (3/8") drive, in box. Sizes:

- ▶ 8 - 10 - 11 - 12 - 13 - 14 - 15 - 16 - 17 - 18 - 19 mm



05530L 29,90 EUR*

PROFESSIONAL SOCKET SET, 1/4", 4-PIECE

6.3 mm (1/4") drive, chromium vanadium, hexagon sockets for maximum torque.

- ▶ Lever changeover ratchet with quick release
- ▶ Handle with 6.3 mm (1/4") drive and output
- ▶ Sockets 3.5-4-4.5-5-5.5-6-7-8-9-10-11-12-13-14 mm
- ▶ PH + PZ1+2
- ▶ Slot 4 - 5.5 - 7 mm
- ▶ T-profile with bore T10-15-20-25-30-40
- ▶ Hexagon 3 - 4 - 5 - 6 - 8 mm
- ▶ Universal joint, 2 extensions, sliding handle
- ▶ Hexagon socket 1.5-2-2.5 mm



06450L 52,50 EUR*

INDUSTRIAL SOCKET SPANNER SET, 1/2", 27-PIECE

Torque and hardness according to DIN, 12.5 mm (1/2") drive, chrome-vanadium steel, hexagon sockets for maximum torque.

- ▶ Reversible ratchet wrench fine-toothed 72 teeth
- ▶ 2 Hinged extensions 125 + 250 mm
- ▶ 1 Cardan joint 12.5 mm (1/2")
- ▶ 1 adaptor for extension / sliding handle
- ▶ 2 Spark plug sockets 16 + 21 mm
- ▶ 20 Sockets with hexagon profile, 8 mm - 32 mm



07624L 74,90 EUR*

INDUSTRIAL SOCKET SPANNER SET, 3/4", DOUBLE HEXAGON, 21-PIECE

- ▶ Ratchet wrench 500 mm
- ▶ Extensions 100 - 200 - 400 mm
- ▶ Sliding handle 450 mm
- ▶ Bi-hexagon sockets 19 - 21 - 22 - 23 - 24 - 26 - 27 - 30 - 32 - 34 - 36 - 38 - 41 - 46 - 48 - 50 mm



07663L 248,90 EUR*

TOOL KIT, 108-PIECE

with three trays and lid compartment, lockable, central locking seals the drawers when the lid is closed. Top handle and robust side handles for safe transport.

Equipped with 3 tool modules and 108 tools in professional quality



06816L EUR*

SPIRAL GROOVE SOCKETS, 1/4", 2,60-8,25 MM, 6-PIECE

6.3 mm (1/4") drive, for removing electrodes from torn off glow plugs in cylinder head while still installed, in plastic case.
Sizes:
▶ 2,60 mm - 3,20 mm - 3,50 mm - 4,50 mm - 6,50 mm - 8,25 mm



05535L 64,99 EUR*

SPIRAL GROOVE SOCKET SET, 3/8", 8 - 19 MM, 11-PIECE

to release badly damaged nuts and bolts. The high-alloy special steel, combined with the aggressive groove profile enables the loosening of all bolts. With 10 mm (3/8") drive and additional external hexagon.



05585L 47,90 EUR*

IMPACT SCREWDRIVER BITS, 1/2", INTERNAL MULTI-TOOTH, M14-M18, 6-PIECE

12.5 mm (1/2") drive, multi-tooth, M14, M16, M18, each with lengths of 40 and 75 mm.
For attaching high-strength screws to the brake carrier and shock absorber screwed connection, brake system, camshaft drive wheel and rear brake calliper, for working on the chassis, and for removing and installing the wheel bearings/wheel hub unit, e.g. on the VW Passat 3C.



10195L 89,90 EUR*

POWER SOCKET SET, 3/4", 21-PIECE

Chromium molybdenum steel for tough and continuous garage use.
▶ Slide handle 450 mm long
▶ Ratchet with screw-fit shaft, length: 500 mm
▶ With quick-action locking on the drive
▶ Extensions in 100 and 250 mm
▶ Cardan joint 105 mm
▶ Sockets 20 mm (3/4"), hexagon, with bore hole and ball groove: 19, 21, 22, 23, 24, 26, 27, 29, 30, 32, 35, 36, 38, 41, 46 and 50 mm
▶ All parts can also be operated with 20 mm (3/4") impact screwdrivers, which means it is no longer necessary to buy additional power sockets for pneumatic tools

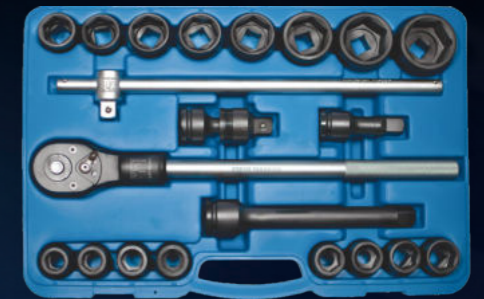

07605L 299,90 EUR*

SPIRAL GROOVE SOCKETS, 1/2", 10-19 MM, 10-PIECE

12.5 mm (1/2") drive, for loosening heavily damaged nuts and bolts. The high-alloy special steel combined with the aggressive groove profile makes it possible to loosen all screws.
Sizes:
▶ 10 - 11 - 12 - 13 - 14 - 15 - 16 - 17 - 19 mm



05545L 79,90 EUR*

SPIRAL SLOT INSERTS, 3/8", 1/2", 2-14 MM, 9-PIECE

for turning out round-turned inner profile screws (for example hexagon socket / XZN tripe square / T-profile) or damaged studs (pre-drill!). The left-turning, tapered spiral profile ensures an optimal force connection between tool and defective screw / stud bolts due to its aggressive surface structure and reliably remove the bolt.
▶ 3/8" inner square / 17 mm outer hexagon: 2, 3, 4, 5, 6 mm
▶ 1/2" inner square / 22 mm outer hexagon: 8, 10, 12, 14 mm



05542L 54,90 EUR*

IMPACT SCREWDRIVER BITS, 1/2", SPLINE, M8-M12, 3-PIECE

3-piece set, made of special steel, 12.5 mm (1/2") drive, suitable for use with impact wrench, XZN tripe square profile.
Also ideal e.g. for screws glued into brake callipers or drive shafts, maximum strength.



05213L 21,50 EUR*

IMPACT SPANNER SOCKET SET, 3/4", 8-PIECE

high strength, for loosening the articulated shaft screws of various vehicles, e.g. Audi, BMW, Citroen, Ford, Opel, Mercedes-Benz, Nissan, Skoda, Seat, Renault, VW, etc.
Content:
▶ 5 extra deep bi hex sockets 27 - 30 - 32 - 34 - 36 mm
▶ 3 Inner hex sockets 14 - 17 - 19 mm



10186L 99,90 EUR*

IMPACT SPANNER SOCKETS, 3/4", 22-38 MM, LONG, 8-PIECE

Suitable for use with impact wrench, with groove and bore hole, 20 mm (3/4") drive.
Sizes:
▶ 22 - 24 - 27 - 28 - 30 - 32 - 36 - 38 mm



07910L 109,90 EUR*

IMPACT SPANNER SOCKETS, 3/4", 22-38 MM, 8-PIECE

suitable for use with impact wrench, with groove and bore hole, 20 mm (3/4") drive.
Sizes:
▶ 22 - 24 - 27 - 28 - 30 - 32 - 36 - 38 mm



07900L 123,90 EUR*

SOCKET SPANNER SET, 1/4", 3/8", 1/2", 184-PIECE

SW STAHL blow mold case „Designed in Germany“ - with separable case and inner foam to avoid rust. Reversible ratchet wrenches and 1/4" bit socket driver with non-slip and ergonomic SW STAHL 2-component handle. Hardness and torque according to DIN, tools made of chrome vanadium steel, 1/4" bits and 1/4" screwdriver sockets made of S2 steel with phosphated surface coating for long-lasting corrosion protection, sockets in hexagon wave profile version for maximum torque.

With 6,3 mm (1/4") drive:

- ▶ 1 each hexagon socket 4 - 14 mm
- ▶ 1 each hexagon socket extra long 4 - 10 mm
- ▶ 1 each E-profile socket E4, E5, E6, E7, E8
- ▶ 1 each bit socket, T-profile T8 - T30
- ▶ ...

With 10,0 mm (3/8") drive:

- ▶ 1 each hexagon socket 10 - 19 mm
- ▶ 1 each hexagon socket extra long 10 - 15 mm
- ▶ 1 each E-profile socket E10 - E18
- ▶ ...

With 12,5 mm (1/2") drive:

- ▶ 1 each hexagon socket 10 - 32 mm
- ▶ 1 each hexagon socket extra long 16 - 19, 22 mm
- ▶ ...



DESIGNED
IN GERMANY

HERE IT GOES
TO THE VIDEO



07784L 99,95 EUR*

SOCKET SPANNER SET, 1/4", 1/2", 97-PIECE

SW STAHL blow mold case „Designed in Germany“ - with separable case and inner foam to avoid rust. Reversible ratchet wrenches and 1/4" bit socket driver with non-slip and ergonomic SW STAHL 2-component handle. Hardness and torque according to DIN, tools made of chrome vanadium steel, 1/4" bits and 1/4" screwdriver sockets made of S2 steel with phosphated surface coating for long-lasting corrosion protection, sockets with hexagon profile for maximum torque.

With 6,3 mm (1/4") drive:

- ▶ 1 each hexagon socket 4, 4.5, 5, 5.5, 6, 7, 8, 9, 10, 11, 12, 13, 14 mm
- ▶ 1 each hexagon socket, extra long 6, 7, 8, 9, 10, 11, 12, 13 mm
- ▶ 1 each bit socket, T-profile T8, T10, T15, T20, T25, T30
- ▶ 1 each bit socket, cross slot PH1, PH2
- ▶ 1 each bit socket, cross slot PZ1, PZ2
- ▶ 1 each bit socket, slot 4, 5.5, 7 mm
- ▶ 1 each bit socket, inner hexagon 3, 4, 5, 6 mm
- ▶ 1 each extension 50, 100 mm
- ▶ Flexible extension 150 mm
- ▶ Reversible ratchet wrench 145 mm, 72 teeth
- ▶ bit socket driver 150 mm
- ▶ Sliding handle 110 mm
- ▶ Adaptor for 6.3 mm bits (1/4")
- ▶ Cardan joint

With 12,5 mm (1/2") drive:

- ▶ 1 each hexagon socket 10 - 32 mm
- ▶ 1 each hexagon socket, extra long 14, 15, 17, 19 mm
- ▶ 1 each spark plug socket 16, 21 mm
- ▶ 1 extension 125, 250 mm
- ▶ Sliding block for extension in 250 mm
- ▶ Reversible ratchet wrench 250 mm, 72 teeth
- ▶ ...



DESIGNED
IN GERMANY

HERE IT GOES
TO THE VIDEO



07797L 79,90 EUR*

SOCKET SPANNER SET, 1/4", 3/8", 1/2", 176-PIECE

6.3 mm + 10 mm + 12.5 mm (1/4" + 3/8" + 1/2") drive, chrome-vanadium steel, hardness and torque according to DIN, sockets in wave profile version for maximum torque.

With 6.3 mm (1/4" drive):

- ▶ 1 each wave profile socket 4, 4.5, 5, 5.5, 6, 7, 8, 9, 10, 11, 12, 13, 14 mm
- ▶ 1 each wave profile socket extra long 4, 5, 6, 7, 8, 9, 10 mm
- ▶ 1 each E-profile E4, E5, E6, E7, E8 mm
- ▶ 1 each extension in 50 and 100 mm
- ▶ ...

With 10 mm (3/8") drive:

- ▶ 1 each wave-profile socket 10, 11, 12, 13, 14, 15, 16, 17, 18, 19 mm
- ▶ 1 each wave profile socket extra long 10, 11, 12, 13, 14, 15 mm
- ▶ 1 each E-profile E10, E11, E12, E14, E16, E18
- ▶ 1 extension 125 mm
- ▶ ...

With 12.5 mm (1/2") drive:

- ▶ 1 each wave profile socket 10, 11, 12, 13, 14, 15, 16, 17, 18, 19, 20, 21, 22, 24, 27, 30, 32 mm
- ▶ 1 each wave profile socket extra long 16, 18 mm
- ▶ 1 each pneumatic heavy-duty socket 17-19-21 mm
- ▶ ...

Combination ratchet wrench, 72 teeth

- ▶ 8, 9, 10, 11, 12, 13, 14, 15, 16, 17, 18, 19 mm

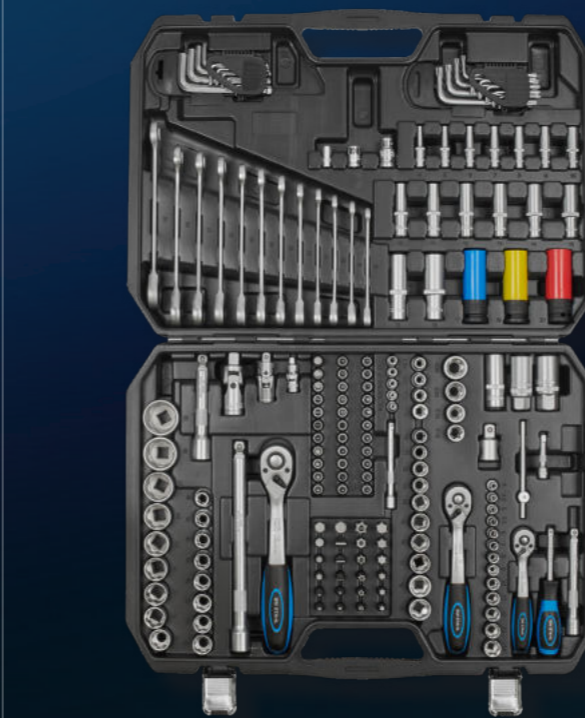

07635L 159,90 EUR*

SOCKET SPANNER SET, 1/4", 48-PIECE

SW STAHL blow mold case „Designed in Germany“ - with separable case and inner foam to avoid rust. Reversible ratchet wrench and 1/4" bit socket driver with non-slip and ergonomic SW STAHL 2-component handle. Hardness and torque according to DIN, tools made of chrome vanadium steel, 1/4" screwdriver sockets made of S2 steel with phosphated surface coating for long-lasting corrosion protection, sockets with hexagon profile for maximum torque.

- ▶ 1 each hexagon sockets 4, 4.5, 5, 5.5, 6, 7, 8, 9, 10, 11, 12, 13, 14 mm
- ▶ 1 each bit socket, cross slot PH 1, PH2, PH3
- ▶ 1 each bit socket, cross slot PZ 1, PZ2, PZ3
- ▶ 1 each bit socket, plain slot 4, 5.5, 7 mm
- ▶ 1 each bit socket, T-profile without tamperproof T10, T15, T20 T25, T30, T40
- ▶ 1 each bit socket, inner hexagon 3, 4, 5, 6, 7, 8 mm
- ▶ 1 each extension 50, 100 mm
- ▶ 1 each allen key 1.5, 2, 3 mm
- ▶ Reversible ratchet wrench 145 mm, 72 teeth
- ▶ Flexible shaft 150 mm
- ▶ Universal joint
- ▶ Bit socket driver 150 mm
- ▶ Adapter from 6.3 mm (1/4") hexagon to square
- ▶ Sliding handle 110 mm



DESIGNED
IN GERMANY

07748L 29,90 EUR*

TOOL CASE, UNIVERSAL, 1/4", 1/2", 120-PIECE

6.3 mm + 12.5 mm (1/4" + 1/2") drive, chrome-vanadium, wave profile sockets for maximum torques. Hardness, torque and dimensional stability according to DIN.



06970L 123,90 EUR*

SCREWING SET FOR E- AND T-PROF-LE, 1/4", 1/2" AND 3/8", 72-PIECE

For E and T-profile screws with and without tamperproof hole, chrome vanadium, supplied in a plastic case, 6.3 mm + 10 mm + 12.5 mm (1/4" + 3/8" + 1/2") drive.

- ▶ Screwdriver with hole T8-10-15-20-25-27-30-40
- ▶ E-profile 12.5mm (1/2"), E12-14-16-18-20-22-24
- ▶ E-profile 6.3mm (1/4"), E4-5-6-7-8-10-11
- ▶ Flat ring spanners E6x8-10x12-14x18-20x24
- ▶ Offset screwdrivers T8-10-15-20-25-27-30-40-45-50-55-60
- ▶ 6.3 mm (1/4") bits without hole T7-8-9
- ▶ 6.3 mm (1/4") bits with hole T10-15-20-25-27-30-40
- ▶ 6.3 mm (1/4") bits without hole T10-15-20-25-27-30
- ▶ Bits, 10 mm drive with hole T40-45-50-55-60-70 x 30 mm short
- ▶ Bits, 10 mm drive without hole T15-20-25-30-40-45-50-55-60 x 75 mm long
- ▶ Telescopic magnetic pick-up tool



04490L 79,90 EUR*

BIT ASSORTMENT, 1/4", 32-PIECE

Chrome vanadium S2 special steel, with colour coding for each profile. Supplied in a case with a transparent lid and adjustable belt clip.

- ▶ 30 bits, 25 mm long
- ▶ Slotted 3-4-5-6 mm
- ▶ Cross-recessed 1-2-2-3
- ▶ PZ 1-2-2-3
- ▶ Internal hexagon socket 3-4-5-6 mm
- ▶ T-profile T10-15-20-25-27-30-40
- ▶ T-profile with bore T10-15-20-25-27-30-40
- ▶ 6.3 mm (1/4") square adapter
- ▶ 1 bit holder with quick release



04126L 14,90 EUR*

BIT ASSORTMENT, 3/8", SPLINE, M5-M12, 11-PIECE

Chromium vanadium, with 12.5 mm (1/2") mandrel adapter

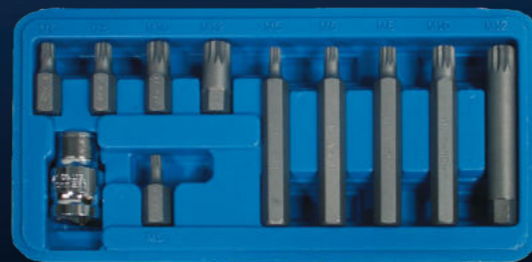

04415L 19,90 EUR*

SCREWDRIVER HEXAGONAL

DESIGNED
IN GERMANY



reddot winner 2023

SCREWDRIVER, HEXAGONAL, 6 X 200 MM, FLEXIBLE SHAFT

- ▶ With flexible shaft
- ▶ 200 mm blade length
- ▶ Non-slip 2-component handle

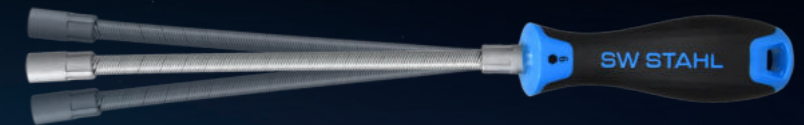

02096L 6,50 EUR*

SCREWDRIVER, HEXAGONAL, 7 X 200 MM, FLEXIBLE SHAFT

- ▶ With flexible shaft
- ▶ 200 mm blade length
- ▶ Non-slip 2-component handle

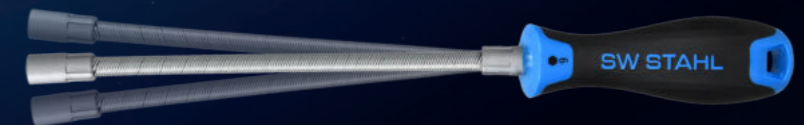

02097L 6,50 EUR*

SCREWDRIVER, HEXAGONAL, 8 X 200 MM, FLEXIBLE SHAFT

- ▶ With flexible shaft
- ▶ 200 mm blade length
- ▶ Non-slip 2-component handle



02098L 7,50 EUR*

LOOSEN UP? NOT REALLY THEIR THING. OUR SCREWDRIVER SETS FOR PROFESSIONALS.

DESIGNED
IN GERMANY

SCREWDRIVER SET, T-PROFILE, 4-PIECE

- ▶ SW STAHL 2-component handle, blue/black
- ▶ With a hole in the handle for torque amplification
- ▶ Blade made of matt chrome-plated S2-steel
- ▶ With black, magnetic tip

Sizes: T6, T7, T8, T9



32813L 14,20 EUR*

SCREWDRIVER SET, SLOT, 5-PIECE

- ▶ SW STAHL 2-component handle, blue/black
- ▶ With a hole in the handle for torque amplification
- ▶ Blade made of matt chrome-plated S2-steel
- ▶ With black, magnetic tip

Sizes: 2.0 mm, 3.0 mm, 4.0 mm, 5.5 mm, 6.5 mm



32811L 16,40 EUR*

SCREWDRIVER SET, SLOT + CROSS, 6-PIECE

- ▶ SW STAHL 2-component handle, blue/black
- ▶ With a hole in the handle for torque amplification
- ▶ Blade made of matt chrome-plated S2-steel
- ▶ With black, magnetic tip

Sizes: 3.0 mm, 4.0 mm, 5.5 mm, 6.5 mm, PH1, PH2



32810L 17,50 EUR*

SCREWDRIVER SET, T-PROFILE, 6-PIECE

- ▶ SW STAHL 2-component handle, blue/black
- ▶ With a hole in the handle for torque amplification
- ▶ Blade made of matt chrome-plated S2-steel
- ▶ With black, magnetic tip

Sizes: T10, T15, T20, T25, T27, T30



32812L 20,90 EUR*

SCREWDRIVER SET, SLOT + CROSS, 6-PIECE

- ▶ SW STAHL 2-component handle, blue/black
- ▶ With a hole in the handle for torque amplification
- ▶ Blade made of matt chrome-plated S2-steel
- ▶ With black, magnetic tip

Sizes: 4.0 mm, 5.5 mm, 6.5 mm, 8.0 mm, PZ1, PZ2



32814L 17,50 EUR*

SCREWDRIVER SET, SLOT + CROSS + T-PROFILE, 6-PIECE

- ▶ SW STAHL 2-component handle, blue/black
- ▶ With a hole in the handle for torque amplification
- ▶ Blade made of matt chrome-plated S2-steel
- ▶ With black, magnetic tip

Sizes: 4.0 mm, 5.5 mm, PH1, PH2, T20, T25



32815L 18,60 EUR*

SCREWDRIVER SET, IMPACT-PROOF, SLOT + CROSS, 5-PIECE

- ▶ SW STAHL 2-component handle, blue/black
- ▶ **Impact-resistant screwdriver with impact cap**
- ▶ With hexagon socket for torque amplification
- ▶ Blade made of matt chrome-plated S2-steel
- ▶ With black, magnetic tip

Sizes: 4.5 mm, 5.5 mm, 8.0 mm, PH1, PH2



32816L 28,90 EUR*

SAFETY SCREWDRIVER SET, ELECTRO, 7-PIECE

- with ergonomically shaped plastic handles, 1000 Volt.
- Plain slot: 2.5 x 75 - 4 x 100 - 5.5 x 125 - 6.5 x 150 mm
- Cross slot: PH 1 x 80, 2 x 100 mm
- Voltage tester 3 x 60 mm



31610L 19,90 EUR*

ALLEN KEY SET, TR PROFILE, T10-T50, 8-PIECE

- Size: T10, T15, T20, T25, T30, T40, T45, T50
- Chromium vanadium
- in patented holder



04484L 15,50 EUR*

SCREWDRIVER SET, HEXAGON, 2-10 MM, BALL HEAD, 8-PIECE

- with ball head
- with T-handle and hanging hole
- chrome vanadium

- Sizes:
- 2 - 3 - 4 mm x 100 mm length
 - 5 - 6 - 7 mm x 150 mm length
 - 8 - 10 mm x 200 mm length



31650L 43,50 EUR*

ALLEN KEY SET, TPR PROFILE, T10-T50, 9-PIECE

- Chromium vanadium
Sizes:
- T10, T15, T20, T25, T27, T30, T40, T45, T50



04494L 24,90 EUR*

T-HANDLE ALLEN SCREWDRIVER SET, T-PROFILE, T10-T50, 9-PIECE

- with T-handle and hanging hole
- chrome vanadium

- Sizes:
- T10 - 15 - 20 - 25 x 100 mm length
 - T27 - 30 - 40 x 150 mm length
 - T45 - 50 x 200 mm length



31660L 42,90 EUR*

T-HANDLE SCREWDRIVER, 1/4", SQUARE

- With 6.3 mm (1/4") drive.
- The freewheeling sleeve handle allows screws and nuts to be screwed in and out quickly
- The sleeve handle can be locked into 3 positions, thus enabling the T-handle to be used in each position
- With additional square on the handle



02086L 26,90 EUR*

THE MAGNETIC **T-HANDLE** EDITION!

10,90 EUR*

02071L

8
MM

11,50 EUR*

02072L

10
MM

12,90 EUR*

02073L

12
MM

13,90 EUR*

02074L

13
MM



With hanging hole

The particularly easy-to-grip and ergonomically shaped 2K handle enables safe working.

Chrome Vanadium

Blade length 230 mm

Hexagon drive

The neodymium magnet placed in the key insert reliably holds the screws/nuts in place and secures them against falling out. This means that even deep-seated screws or nuts can be mounted reliably.

DESIGNED
IN GERMANY

THE SET

Chromium vanadium, magnetic, with hanging hole.

- 8 x 230mm
- 10 x 230 mm
- 13 x 230 mm



02052L

34,90 EUR*



reddot winner 2023

PLIERS SET, 3-PIECE

- ▶ Manufactured according to the respective DIN ISO 5745 / 5746 / 5749
- ▶ For holding, gripping, bending and cutting work
- ▶ Gripping zones for flat and round material
- ▶ Suitable for maximum socket size 19 mm or maximum head diameter 20 mm due to the integration of ring spanner and torch hole
- ▶ For cutting soft and hard wires with tensile strength up to 1,800 N/mm² and aluminium and copper wire with up to 12 mm diameter
- ▶ Gripping teeth and cutting edges additionally induction hardened
- ▶ Special power joint with optimum lever transmission for easy and tireless work
- ▶ Made of chrome vanadium steel, forged, oil-hardened
- ▶ Finished with corrosion-resistant and durable „Teflon finish“ surface
- ▶ Ergonomic and non-slip 2-component handles



reddot winner 2023



DESIGNED
IN GERMANY

40200L 36,90 EUR*

WATER PUMP PLIERS, 250 MM

- ▶ Manufactured according to DIN ISO 8976
- ▶ For holding, gripping and bending work
- ▶ Suitable for maximum socket size or maximum head diameter 50 mm
- ▶ Compact, narrow shape with optimum jaw geometry for working in confined spaces and positions otherwise inaccessible
- ▶ Quick precise adjustment and release by pressing the button – with fine teeth
- ▶ Double-toothed jaws with self-locking serration
- ▶ Gripping teeth additionally induction hardened
- ▶ Box joint with wide guide surfaces
- ▶ Finger trap protection for safe work, prevents injuries caused by squeezing
- ▶ Made of chrome vanadium steel, forged, oil-hardened
- ▶ Finished with corrosion-resistant and durable „Teflon finish“ surface
- ▶ Optimum handle position and shape for best power transmission
- ▶ Ergonomic and non-slip 2-component handles



reddot winner 2023

40387L 24,90 EUR*

TELEPHONE PLIERS, STRAIGHT, 200 MM

- ▶ Manufactured according to DIN ISO 5745
- ▶ For holding, gripping, bending and cutting work
- ▶ With long, flat-round jaws
- ▶ Serrated inside jaws
- ▶ For cutting soft and hard wires with tensile strength up to 1,800 N/mm² and aluminium and copper wire with up to 13 mm diameter
- ▶ Gripping teeth and cutting edges additionally induction hardened
- ▶ Special power joint with optimum lever transmission for easy and tireless work
- ▶ Made of chrome vanadium steel, forged, oil-hardened
- ▶ Finished with corrosion-resistant and durable „Teflon finish“ surface



reddot winner 2023

40785L 14,90 EUR*

COMBINATION PLIERS, 180 MM

- ▶ Manufactured according to DIN ISO 5746
- ▶ For holding, gripping, bending and cutting work
- ▶ Gripping zones for flat and round material
- ▶ For cutting soft and hard wires with tensile strength up to 1,800 N/mm² and aluminium and copper wire with up to 12 mm diameter
- ▶ Gripping teeth and cutting edges additionally induction hardened
- ▶ Special power joint with optimum lever transmission for easy and tireless work
- ▶ Made of chrome vanadium steel, forged, oil-hardened
- ▶ Finished with corrosion-resistant and durable „Teflon finish“ surface



reddot winner 2023

40484L 14,90 EUR*

SIDE CUTTER, 180 MM

- ▶ Manufactured according to DIN ISO 5749
- ▶ Precision cutting edge for finest wires
- ▶ Cutting edge hardness approx. 62 HRC
- ▶ Cutting edges additionally induction hardened
- ▶ For cutting soft and hard wires with tensile strength up to 1,800 N/mm² and aluminium and copper wire with up to 13 mm diameter
- ▶ Special power joint with optimum lever transmission for easy and tireless work
- ▶ Made of chrome vanadium steel, forged, oil-hardened
- ▶ Finished with corrosion-resistant and durable „Teflon finish“ surface
- ▶ Ergonomic and non-slip 2-component handles



NEW
PRODUCT

reddot winner 2023

40584L 17,90 EUR*

TELEPHONE PLIERS, BENT, 200 MM

- ▶ Manufactured according to DIN ISO 5745
- ▶ For holding, gripping, bending and cutting work
- ▶ With long, 45°-angled, flat-round jaws
- ▶ Serrated inside jaws
- ▶ For cutting soft and hard wires with tensile strength up to 1,800 N/mm² and aluminium and copper wire with up to 13 mm diameter
- ▶ Gripping teeth and cutting edges additionally induction hardened
- ▶ Special power joint with optimum lever transmission for easy and tireless work
- ▶ Made of chrome vanadium steel, forged, oil-hardened
- ▶ Finished with corrosion-resistant and durable „Teflon finish“ surface



reddot winner 2023

40885L 14,90 EUR*

SIDE CUTTER, 160 MM

- ▶ Manufactured according to DIN ISO 5749
- ▶ Precision cutting edge for finest wires
- ▶ Cutting edge hardness approx. 62 HRC
- ▶ Cutting edges additionally induction hardened
- ▶ For cutting soft and hard wires with tensile strength up to 1,800 N/mm² and aluminium and copper wire with up to 11 mm diameter
- ▶ Special power joint with optimum lever transmission for easy and tireless work
- ▶ Made of chrome vanadium steel, forged, oil-hardened
- ▶ Finished with corrosion-resistant and durable „Teflon finish“ surface



reddot winner 2023

40583L 14,90 EUR*

LEVER-FORCE SIDE CUTTER, 200 MM

- ▶ Manufactured according to DIN ISO 5749
- ▶ Precision cutting edge for piano wire (D2 quality)
- ▶ Cutting edge hardness approx. 62 HRC
- ▶ Cutting edges additionally induction hardened
- ▶ For cutting soft and hard wires with tensile strength up to 1,800 N/mm² and piano wire with up to 2.300N/mm² and 2,5 mm diameter
- ▶ Special power joint with optimum lever transmission for easy and tireless work
- ▶ Made of chrome vanadium steel, forged, oil-hardened
- ▶ Finished with corrosion-resistant and durable „Teflon finish“ surface



NEW
PRODUCT

reddot winner 2023

40685L 24,90 EUR*

BALL-JOINT EXTRACTOR, FOR HGVS, 36 X 90 MM

For quickly and efficiently removing ball joints on track rods and suspension joints.

- ▶ Fork opening: 36 mm
- ▶ Clearance: max. 90 mm



12101L 149,90 EUR*

HINGE PIN EXTRACTOR, ADJUSTABLE, 24 X 50 MM

for quickly and efficiently removing ball joints on track rods and suspension joints.

- ▶ Easy to use thanks to lever transmission
- ▶ Reinforced spindle with fine thread and centring ball

Fork opening: 24 mm Clearance: max. 50 mm



12200L 92,30 EUR*

PRECISION INSIDE CALIPER, 50 - 160 MM

The set includes different measuring tips that cover a measuring range from 50 - 160 mm. It is suitable for measuring piston bores in engine blocks or in wheel bearing casings in petrol and diesel vehicles as well as for taking a range of other measurements.



72390L 99,90 EUR*

CALIPER GAUGE, DIGITAL, 150 MM

Rust-free, in a box.

- ▶ With depth measurement
- ▶ 150 mm measuring range
- ▶ With mm/inch scale, indicating nonius 1/100 mm
- ▶ Adjustable 0-position and mm/inch setting
- ▶ +/- display
- ▶ Inc. battery

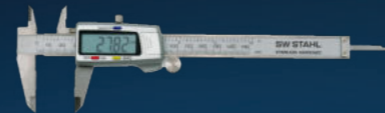

72350L 24,90 EUR*

CIRCLIP PLIERS SET, 75 MM, 4-PIECE

- ▶ For inner and outer circlips / small circlips
- ▶ Tip diameter 1 mm
- ▶ Insulated handles
- ▶ Straight and bent



41470L 18,90 EUR*

CIRCLIP PLIERS SET, 225 MM, 4-PIECE

forged, handles rough foam-insulated, 225 mm long in artificial leathercase.

- ▶ Inner, straight, 42-4,5 mm
- ▶ Inner, bent, 39-4 mm
- ▶ Outer, straight, 4-32 mm
- ▶ Outer, bent, 4-35 mm



41415L 46,90 EUR*

PRECISION MECHANIC'S TOOL SET, 10-PIECE

In case.

- ▶ Universal pliers 120 mm
- ▶ Side-cutting pliers 115 mm
- ▶ Long-nosed pliers bent 125 mm
- ▶ Long-nosed pliers straight 130 mm
- ▶ 3 electronic plain slot screwdrivers 2 - 2.5 - 3 x 50 mm
- ▶ 3 electronic cross-slot screwdrivers sizes 00 - 0 - 1 x 50 mm



40706L 24,90 EUR*

FILE SET, 5-PIECE

Workshop file set with the most common metal files

- ▶ Workshop file, flat
- ▶ Workshop file, half round
- ▶ Workshop file, round
- ▶ Workshop file, triangular
- ▶ Workshop file, square



reddot winner 2023

DESIGNED
IN GERMANY

90940L 23,50 EUR*

WORKSHOP FILE, FLAT

- ▶ For surfaces and right-angled geometries
- ▶ Rectangular file with cut on three sides, one side without cut

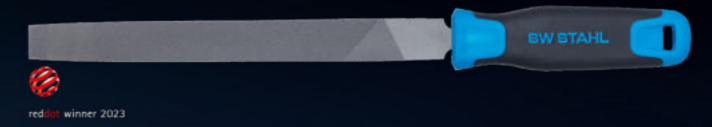

90941L 5,10 EUR*

WORKSHOP FILE, HALF ROUND

- ▶ Suitable for radii and half round profiles
- ▶ Half-round tapered file with cut on two sides



90942L 6,10 EUR*

WORKSHOP FILE, ROUND

- ▶ For tight radii and profiles with inner radii
- ▶ Round file with a circumferential cut



90943L 5,10 EUR*

WORKSHOP FILE, TRIANGULAR

- ▶ For corners and flat surfaces
- ▶ Triangular, tapered file with cut on three sides



90944L 5,10 EUR*

WORKSHOP FILE, SQUARE

- ▶ For filing angled profiles
- ▶ Square, tapered file cut on four sides

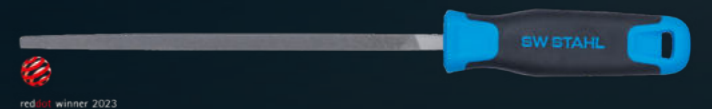

90945L 5,10 EUR*

REAMING TOOL SET, 17-PIECE

For severely damaged screws and nuts as well as torn stud bolts.

- ▶ 4 inserts, 12.5 mm (1/2") / hexagon drive 21 mm, 6 - 12 mm
- ▶ 8 special inserts 10 mm (3/8") for worn screws/nuts, 9 - 19 mm
- ▶ 5 screw extractors with square drive for M3-6 / M6-8 / M8-11 / M11-14 / M14-18 (drill bolt beforehand)



04166L 99,90 EUR*

THERMOMETER, INFRARED, DIGITAL

with laser pointer, automatic shutdown, illuminated digital display, ideal for measurements on hot or rotating parts, liquids or spots that are difficult to reach.

- ▶ Measuring range -50 to +550°C
- ▶ Measuring accuracy +/- 2.5%
- ▶ Operating temperature: 0° - 50°C
- ▶ Distance factor 12 : 1
- ▶ Switchable °F / °C
- ▶ Incl. 2x AAA battery



72360L 57,90 EUR*

HAMMER ASSORTMENT, WITH HEAD PROTECTION, 3-PIECE

High-quality hammer assortment for maximum working safety.

- ▶ Hickroy handle, extremely impact- proof
- ▶ Safety pin
- ▶ Round safety wedge
- ▶ Forged head
- ▶ Manufactured according to DIN 1041

Head weights: 300 - 500 - 800 g



50930L 24,90 EUR*

SOFT-FACED, NON-RECOIL HAMMER, 2,100 G

Non-recoil, completely rubberised.

- ▶ With plastic shaft
- ▶ Steel balls in the hammer head prevent the hammer from recoiling
- ▶ Specially designed to loosen rusty rims when changing tyres



51113L 22,50 EUR*

MINI HOOK SET, 4-PIECE

ideal for O-rings, seals etc., with non-slip handles.

- ▶ Straight tip
- ▶ 90° tip
- ▶ Hook tip
- ▶ Parting awl



94871L 11,50 EUR*

SCRAPER AND HOOK SET, 5-PIECE

- ▶ Hardened
- ▶ Scraper 262 mm
- ▶ Scraper 232 mm
- ▶ Hook 90°
- ▶ Parting awl
- ▶ Hook 45°



94880L 14,90 EUR*

NON-RECOIL HAMMER, WITHOUT RECOIL, 5,250 G

non-recoil, completely rubberised.

- ▶ Made of polyurethane glass fibre
- ▶ The steel balls in the hammer head prevent the hammer recoiling
- ▶ Especially for use during tyre changing, for loosening rims that have become rusted tight
- ▶ For striking bearings, bushings etc. into place



51115L 89,90 EUR*

STEEL STAMPING LETTERS, 6 MM, 27-PIECE

for striking into steel an iron with consistent font, according to DIN 1451, engraving on offset surface and depth limitation.



08803L 13,90 EUR*

STICKER SCRAPER, 40MM BLADE WIDTH

- ▶ To remove stickers and other labels such as road tax discs
- ▶ Retractable and easily replaceable blade
- ▶ Robust metal casing
- ▶ The 2-component grip enables easyhandling and maximum force transmission



94814L 5,50 EUR*

SEAL SCRAPER SET, RUSTPROOF, 4-PIECE

Non-rusting, all with a handle length of 115 mm.

- ▶ 100 x 31 mm, thickness 1.1 mm
- ▶ 100 x 31 mm, thickness 2.4 mm
- ▶ 50 x 20 mm, thickness 1.1 mm
- ▶ 50 x 20 mm, thickness 2.4 mm



94840L 29,90 EUR*

STEEL STAMPING LETTERS, 8 MM, 27-PIECE

for striking into steel an iron with consistent font, according to DIN 1451, engraving on offset surface and depth limitation.



08804L 14,90 EUR*

UNIVERSAL REMOVER SET, 3-PIECE

with forged jaws, can be reversed for inner and outer.

- ▶ 2-arm, 75 mm
- ▶ 3-arm, 100 mm
- ▶ 3-arm, 150 mm



10405L 43,90 EUR*

NUT SPLITTER, 13-24 MM

for the mechanical splitting of faulty or overwound nuts without damaging the thread.



11005L 12,50 EUR*

NUT SPLITTER, 7-16 MM

for the mechanical splitting of faulty or overwound nuts without damaging the thread.



11000SB 10,90 EUR*

SCREWDRIVER BITS, 1/2", HEXAGON, 5-19 MM, 30-PIECE

12.5 mm (1/2") drive, chrome-vanadium S2-special steel

- ▶ 55 mm long 5 - 6 - 7 - 8 - 10 - 12 - 14 - 17 - 19 mm
- ▶ 100 mm long 5 - 6 - 7 - 8 - 10 - 11 - 12 - 13 mm
- ▶ 140 mm long 5 - 6 - 7 - 8 - 10 - 12 - 14 mm
- ▶ 200 mm long 5 - 6 - 7 - 8 - 10 - 12 mm

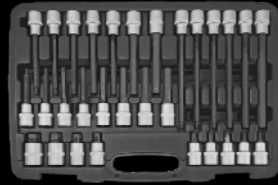

04923L 79,90 EUR*

SCREWDRIVER BITS, 1/2", SPLINE, M5-M16, 26-PIECE

12.5 mm (1/2") drive, chromium vanadium S2-special steel

- ▶ 55 mm long M5 - M6 - M8 - M9 - M10 - M12 - M14 - M16
- ▶ 100 mm long M5 - M6 - M8 - M9 - M10 - M12 - M14
- ▶ 140 mm long M5 - M6 - M8 - M9 - M10 - M12 - M14
- ▶ 200 mm long M8 - M10 - M12 - M14



04424L 79,90 EUR*

CREEPER

made of plastic, ergonomically formed, with utility boxes for consumables at the side.

- ▶ 6 casters
- ▶ 130 kg capacity



20950L 39,90 EUR*

CONSUMABLES DISH, MAGNETIC

magnetic, made of stainless steel, for holding screws, nuts etc.



07356L 5,90 EUR*

SCREWDRIVER BITS, 1/2", RB PROFILE, M5-M14, 32-PIECE

12.5 mm (1/2") drive, chromium vanadium S2-special steel.

- ▶ Length: 55 and 100 mm M5 - M6 - M7 - M8 - M9 - M10 - M12 - M13 - M14
- ▶ Length: 140 and 200 mm M8 - M9 - M10 - M10.3 - M12 - M13 - M14

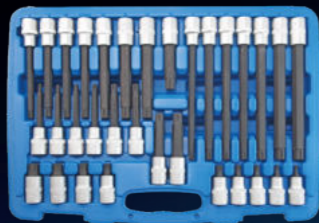

04422L 79,90 EUR*

SCREWDRIVER BITS, 1/2", T-PROFILE, T20-T70, 32-PIECE

12.5 mm (1/2") drive, chromium vanadium S2-special steel.

- ▶ 55 und 100 mm long T20 - T25 - T27 - T30 - T40 - T45 - T50 - T55 - T60 - T70
- ▶ 140 und 200 mm long T40 - T45 - T50 - T55 - T60 - T70

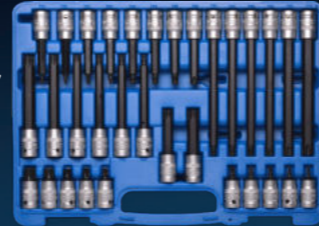

04423L 79,90 EUR*

CONSUMABLES DISH, MAGNETIC

with magnetic clamp, diameter ca. 150 mm.

The one-sided higher shape makes it possible to store non-magnetic parts made of aluminium, brass and stainless steel for the first time, making it indispensable at any workstation.



07358L 7,90 EUR*

STEP LADDER, MADE OF ALUMINIUM, FOLDABLE, 1-STEP

- ▶ Max. load: 150 kg
- ▶ Made of aluminium
- ▶ Weight: 1.70 kg

Dimensions:

- ▶ Unfolded: 440 x 190 x 680 mm
- ▶ Folded: 440 x 62.50 x 610 mm



20921L 36,90 EUR*

BIT ASSORTMENT, 1/4", 208-PIECE

incl. magnetic screwdriver bit holder, magnetic quick release bit holder and 1/4" socket adapter.

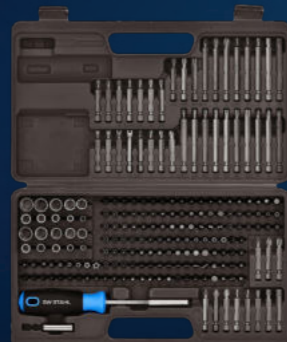

04141L 39,90 EUR*

SPECIAL WHEEL NUT SOCKETS, FORD, 2-PIECE

Special tool set for wheel nuts with stainless steel caps, as often used by Ford. Over time the stainless steel caps get lost and normal wheel nut sockets are then too big for the wheel nuts and damage the hexagon. The set includes 2 special wheel nut sockets with sizes 18.5 / 19.5 / 20.5 and 21.5 mm.



07884L 26,90 EUR*

WORK PLATFORM, MADE OF ALUMINIUM, FOLDABLE

Convenient working platform for hard-to-reach spaces.

- ▶ Dimensions 127 x 38 x 49.5 cm (L x W x H)
- ▶ Folds away to save space
- ▶ Sturdy aluminium design
- ▶ Non-slip platform surface
- ▶ Maximum load 150 kg

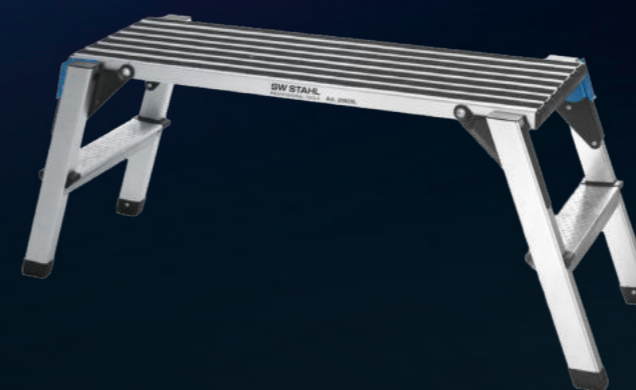

20920L 99,00 EUR*

STEP LADDER, MADE OF ALUMINIUM, FOLDABLE, 3-STEP

- ▶ Max. load: 150 kg
- ▶ Made of aluminium
- ▶ Weight: 2.60 kg

Dimensions:

- ▶ Unfolded: 400 x 180 x 230 mm
- ▶ Folded: 400 x 270 x 280 mm



20922L 54,90 EUR*

SPIRAL DRILL SET, HSS-G TIN, 170-PIECE

HSS, ground, DIN 338, TITANIUM nitrified for long tool life, in metal box.

- ▶ 10 units each 1.0 - 8.0 x 0.5 mm increasing
- ▶ 5 units each 8.5 - 10.0 x 0.5 mm steps



80210L 119,90 EUR*

THREAD CUTTING TOOL SET, TIN, M2-M18, 110-PIECE

- ▶ Normal threads
- ▶ Fine threads
- ▶ Tool holder
- ▶ Die holder
- ▶ Adapter

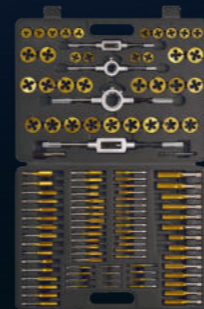

82251L 149,90 EUR*

THE NEW PNEUMATIC IMPACT WRENCH EDITION!

DESIGNED
IN GERMANY

NEW
PRODUCT

PNEUMATIC IMPACT WRENCH, 1/2", 1.300 NM, 118 MM

12.5 mm (1/2") drive

- ▶ Extra short: 118 mm
- ▶ High performance twin hammer mechanism
- ▶ Threefold torque selection
- ▶ Max. torque 3rd speed: 750 Nm
- ▶ Max. release torque: 1.300 Nm
- ▶ Fatigue-proof work due to low net weight (1.300 g)
- ▶ Single handed switching for clockwise/anticlockwise running
- ▶ Very low vibration
- ▶ Ergonomic 2-component (TPR+Nylon) handle with special non-slip texture
- ▶ 1/4" inlet nipple included



S3465 69,95 EUR*

PNEUMATIC IMPACT WRENCH, 1/2", 1.800 NM

12.5 mm (1/2") drive

- ▶ High performance twin hammer mechanism
- ▶ Threefold torque selection
- ▶ Max. torque 3rd speed: 1.200 Nm
- ▶ Max. release torque: 1.800 Nm
- ▶ Fatigue-proof work due to low net weight
- ▶ Single handed switching for clockwise/anticlockwise running
- ▶ Very low vibration
- ▶ Ergonomic 2-component (TPR+Nylon) handle with special non-slip texture
- ▶ 1/4" inlet nipple included



S3460 64,95 EUR*

PNEUMATIC IMPACT WRENCH, 3/4", 1.900 NM

20 mm (3/4") drive

- ▶ High performance twin hammer mechanism
- ▶ Threefold torque selection
- ▶ Max. torque 3rd speed: 1.300 Nm
- ▶ Max. release torque: 1.900 Nm
- ▶ Fatigue-proof work due to low net weight
- ▶ Single handed switching for clockwise/anticlockwise running
- ▶ Very low vibration
- ▶ Ergonomic 2-component (TPR+Nylon) handle with special non-slip texture
- ▶ 1/4" inlet nipple included



S3470 69,95 EUR*

PNEUMATIC IMPACT WRENCH, 1/4", 9-PIECE

Especially for the removal of jammed glow plugs.

- ▶ Loosening torque adjustable in 4 stages:
- ▶ Loosening torque from 10 to 40 Nm
- ▶ 5 IMPACT hexagon sockets 50 mm long 8-9-10-11-12 mm



S3224 189,00 EUR*

PNEUMATIC ANGLE IMPACT WRENCH, 1/2", 450 NM

12.5 mm (1/2") drive.

- ▶ With extremely low design height of 69 mm, for spots that are hard to reach
- ▶ Jumbo hammer mechanism for undoing screws that are stuck
- ▶ Extremely lightweight (1.16 kg) and easy to hold for long periods of time without tiring
- ▶ Single-handed switching for clockwise/anti-clockwise running
- ▶ 3 torque settings for clockwise running
- ▶ Includes 6.3 mm (1/4") pneumatic connector



S3296 179,90 EUR*

PNEUMATIC IMPACT WRENCH, 3/4", 1.750 NM

20 mm (3/4") drive.

- ▶ High-performance twin hammer mechanism
- ▶ Lightweight and easy to hold for long periods of time without tiring
- ▶ Function for switching between clockwise/anti-clockwise running
- ▶ Very low-vibration
- ▶ 3 torque settings
- ▶ With non-slip handle
- ▶ Includes 6.3 mm (1/4") pneumatic connector



HERE IT GOES
TO THE VIDEO



S3266 99,90 EUR*

PNEUMATIC IMPACT WRENCH, 1/2", 1.756 NM

12.5 mm (1/2") drive.

- ▶ High-performance twin hammer mechanism
- ▶ Extremely lightweight and easy to hold for long periods of time without tiring
- ▶ Function for switching between clockwise/anti-clockwise running
- ▶ Very quiet; protects hearing
- ▶ Very low-vibration
- ▶ 3 torque settings
- ▶ With non-slip handle
- ▶ Includes 6.3 mm (1/4") pneumatic connector



S3276 159,90 EUR*

PNEUMATIC IMPACT WRENCH, 3/4", 3,200 NM

- 20 mm (3/4") drive.
- ▶ High-performance twin hammer mechanism
 - ▶ Very light aluminium housing
 - ▶ Very quiet; protects hearing
 - ▶ Low-vibration
 - ▶ 3 torque settings
 - ▶ With non-slip handle
 - ▶ Includes 10 mm (3/8") pneumatic connector



S3277 539,90 EUR*

PNEUMATIC BIT IMPACT WRENCH, 1/4", 110 NM

- ▶ With 110 Nm loosening torque
- ▶ Hexagon drive: 6.3 mm (1/4")
- ▶ Maximum speed: 13,000 rpm.
- ▶ Single-handed switching for clockwise/anti-clockwise running
- ▶ Includes 6,3 mm (1/4") inlet nipple



S3231 59,90 EUR*

PNEUMATIC IMPACT WRENCH, 1", 3,800 NM

- 25 mm (1") drive.
- ▶ Short drive spindle
 - ▶ High-performance twin hammer mechanism
 - ▶ Very light aluminium housing
 - ▶ Low-vibration
 - ▶ 3 torque settings
 - ▶ Includes 12.5 mm (1/2") pneumatic connector



S3279 759,90 EUR*

PNEUMATIC IMPACT RATCHET WRENCH, 1/2", 122 NM

- This impact ratchet wrench with pin clutch impact mechanism is perfect for loosening and tightening very tight screw connections.
- Special features:
- ▶ Pin clutch impact mechanism
 - ▶ Non-rebound mechanism for low impact work
 - ▶ Cold insulated and non-slip handle
 - ▶ Easy to switch (left / right)
 - ▶ Includes 6.3 mm (1/4") pneumatic connector



S3290 199,90 EUR*

PNEUMATIC IMPACT WRENCH, 1", 3,800 NM

- 25 mm (1") drive.
- ▶ Long drive spindle, 210 mm
 - ▶ High-performance twin hammer mechanism
 - ▶ Very light aluminium housing
 - ▶ Low-vibration
 - ▶ 3 torque settings
 - ▶ Includes 12.5 mm (1/2") pneumatic connector



S3280 876,90 EUR*

PNEUMATIC IMPACT WRENCH, 1/2", 1,300 NM

- 12.5 mm (1/2") drive.
- ▶ High-performance twin hammer mechanism
 - ▶ Extremely lightweight and easy to hold for long periods of time without tiring
 - ▶ Function for switching between clockwise /anti-clockwise running
 - ▶ Very quiet; protects hearing
 - ▶ Very low-vibration
 - ▶ 3 torque settings
 - ▶ With non-slip handle
 - ▶ Includes 6.3 mm (1/4") pneumatic connector



S3275 179,90 EUR*

MINI PNEUMATIC RATCHET WRENCH, 1/4" AND 3/8"

- ▶ With interchangeable drive (1/4" and 3/8")
- ▶ Ratchet head protected against dirt
- ▶ Easy to switch (left / right) by turning the interchangeable drive
- ▶ Cold insulated and non-slip handle
- ▶ Extremely lightweight and easy to hold for long periods of time without tiring
- ▶ Rear exhaust through the handle
- ▶ Very low-vibration
- ▶ Includes 6.3 mm (1/4") pneumatic connector



S3291 149,90 EUR*

PNEUMATIC RATCHET WRENCH, 1/4", 41 NM

- ▶ Fatigue-proof work as a result of extremely low net weight
- ▶ Very quiet
- ▶ Rear exhaust
- ▶ Cold insulated and anti-slip handle
- ▶ Very low-vibration



S3281 87,90 EUR*

PNEUMATIC RATCHET WRENCH, 3/8", 41 NM

- ▶ Ratchet head protected against dirt
- ▶ Easy to switch (left / right)
- ▶ Rear exhaust
- ▶ Cold insulated and anti-slip handle
- ▶ Includes 6.3 mm (1/4") pneumatic connector



S3282 124,90 EUR*

PNEUMATIC RATCHET WRENCH, 1/2", 68 NM

- ▶ Fatigue-proof work as a result of extremely low net weight
- ▶ Gentle on hearing due to low sound pressure levels
- ▶ Rear exhaust
- ▶ Cold insulated and anti-slip handle
- ▶ Very low-vibration



S3283 139,90 EUR*

PNEUMATIC ANGLE GRINDER

The powerful pneumatic motor is perfect for grinding, cutting and roughing.

- ▶ Output: 1.04 KW (1.4 HP)
- ▶ Speed: 12,000 rpm
- ▶ For grinding discs with a diameter of max. 125 x 22.2 mm
- ▶ For grinding discs with a thickness of 0.8 - 6 mm
- ▶ Spindle thread: M14 x 2
- ▶ Includes 6.3 mm (1/4") pneumatic connector



S3297 199,90 EUR*

PNEUMATIC MINI ANGLE GRINDER, 16-PIECE

Suitable for small-scale repairs, particularly in hard-to-reach places.

- ▶ Max. 20,000 revolutions per minute
- ▶ For discs with max. Ø 50 mm, arbour hole Ø 10 mm
- ▶ Includes 1/4" pneumatic connector

The set contains the following components:

- ▶ 1 mini pneumatic angle grinder
- ▶ 9x grinding discs Ø 50 mm
- ▶ 5x cutting discs Ø 50 mm
- ▶ 1x safety glasses



S3294 129,90 EUR*

2-WAY AIR PISTOL WITH REGULATION AND VENTURI NOZZLE, 4-PIECE

- ▶ Allows working pressure regulation through „Flow Control“ function
- ▶ With three interchangeable nozzles
- ▶ Compressed air connection: 1/4"

Content:

- ▶ 2-way air pistol
- ▶ Short nozzle: 24 mm
- ▶ Long nozzle: 119 mm
- ▶ Venturi nozzle: 83 mm
- ▶ Plastic scratch protection for the long nozzle



25011L 25,90 EUR*

PNEUMATIC AXIAL GRINDER SET, 1/4", 17-PIECE

ultra compact, with 10 grinding stones and oil spray device. For use in spots that are difficult to access, for machining intake ducts etc. in the tuning sector.

- ▶ Axis diameter of the grinding and milling heads 3 mm
- ▶ Only 135 mm long (without hose), 16 mm diameter
- ▶ Very low in weight - less than 200 g (without hose)

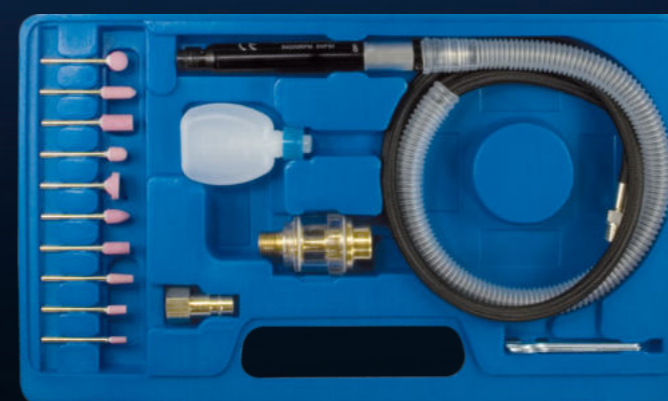

S3263 37,90 EUR*

PNEUMATIC ANGLE GRINDER, LONG VERSION

- ▶ Extra long flat head
- ▶ For 100 mm grinding wheel size
- ▶ Grinding wheel adapter 16 mm
- ▶ Speed: 14,000 rpm



S3268 159,90 EUR*

PNEUMATIC CHIPPING HAMMER, 9-PIECE

with 4 different chisels, compressed air coupling and pressure adjustment screw.

- ▶ Pneumatic chipping hammer 150 mm with retaining spring
- ▶ Working pressure 6,2 bar (90 psi)
- ▶ Air consumption 113 l/min
- ▶ Compressed air connection 1/4"
- ▶ Blow count 4500/min
- ▶ 4 pneumatic chisels
- ▶ 1x point chisel
- ▶ 3x flat chisel, 20 mm wide
- ▶ Automatic oiler
- ▶ Hose adapter
- ▶ Oil can



S3213 33,90 EUR*

PNEUMATIC MINI POLISHER, 5-PIECE

Suitable for small-scale repairs and polishing headlight covers.
Special features:

- ▶ Adjustable speed
- ▶ Max. 3200 rpm
- ▶ Rear exhaust through the handle
- ▶ Includes 6.3 mm (1/4") pneumatic connector

The set contains the following components:

- ▶ 1x pneumatic polisher
- ▶ 1x Velcro pad holder, Ø 75 mm
- ▶ 2x polishing pads (yellow and white), Ø 90 mm
- ▶ 1x buffing pad, Ø 90 mm



S3292 135,90 EUR*

VIBRO PNEUMATIC CHISEL SET

contains 4 different impact chisels with different profiles.
Ideal for support e.g.:

- ▶ when loosening nuts and screw connections which have rusted tight
- ▶ for pressing the supporting joint cone out of the rear axle
- ▶ with rust solvents, since they penetrate deeper due to the vibration
- ▶ incl. compressed air nipple 1/4"
- ▶ with quick-action chuck
- ▶ with backlash damping
- ▶ stroke rate: 2100/min.
- ▶ chisel shaft: around 10 mm
- ▶ working stroke: 10 mm
- ▶ working pressure: 6.2 bar

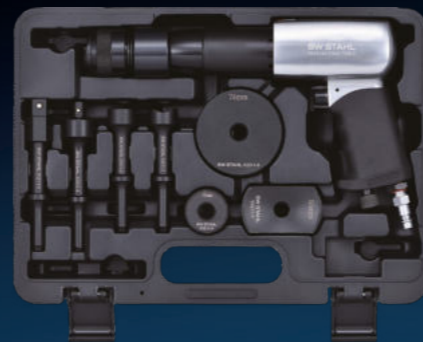

S3211 199,90 EUR*

2" VELCRO PAD, M6X1

suitable for use with mini air polisher as well as with mini air random orbital sander S3293.

- ▶ M6 x 1 mm



S3293-33 31,90 EUR*

3" VELCRO PAD, M6X1

suitable for use with mini air polisher as well as with mini air random orbital sander S3293. M6 x 1 mm



S3292-33 36,00 EUR*

ABRASIVE PAPER



DESCRIPTION	ARTICLE	PRICE
Abrasive paper, ø 50 mm, grain 60, 10-piece	S3293-50/60	5,60 EUR*
Abrasive paper, ø 50 mm, grain 80, 10-piece	S3293-50/80	5,60 EUR*
Abrasive paper, ø 50 mm, grain 120, 10-piece	S3293-50/120	5,60 EUR*
Abrasive paper, ø 50 mm, grain 180, 10-piece	S3293-50/180	5,60 EUR*
Abrasive paper, ø 50 mm, grain 240, 10-piece	S3293-50/240	5,60 EUR*
Abrasive paper, ø 50 mm, grain 320, 10-piece	S3293-50/320	5,60 EUR*
Abrasive paper, ø 50 mm, grain 400, 10-piece	S3293-50/400	5,60 EUR*
Abrasive paper, ø 50 mm, grain 600, 10-piece	S3293-50/600	5,60 EUR*
Abrasive paper, ø 50 mm, grain 1000, 10-piece	S3293-50/1000	5,60 EUR*
Abrasive paper, ø 50 mm, grain 1500, 10-piece	S3293-50/1500	5,60 EUR*
Abrasive paper, ø 50 mm, grain 2000, 10-piece	S3293-50/2000	5,60 EUR*
Abrasive paper, ø 75 mm, grain 60, 10-piece	S3293-75/60	6,60 EUR*
Abrasive paper, ø 75 mm, grain 80, 10-piece	S3293-75/80	6,60 EUR*
Abrasive paper, ø 75 mm, grain 120, 10-piece	S3293-75/120	6,60 EUR*
Abrasive paper, ø 75 mm, grain 180, 10-piece	S3293-75/180	6,60 EUR*
Abrasive paper, ø 75 mm, grain 240, 10-piece	S3293-75/240	6,60 EUR*
Abrasive paper, ø 75 mm, grain 320, 10-piece	S3293-75/320	6,60 EUR*
Abrasive paper, ø 75 mm, grain 400, 10-piece	S3293-75/400	6,60 EUR*
Abrasive paper, ø 75 mm, grain 600, 10-piece	S3293-75/600	6,60 EUR*
Abrasive paper, ø 75 mm, grain 1000, 10-piece	S3293-75/1000	6,60 EUR*
Abrasive paper, ø 75 mm, grain 1500, 10-piece	S3293-75/1500	6,60 EUR*
Abrasive paper, ø 75 mm, grain 2000, 10-piece	S3293-75/2000	6,60 EUR*

PNEUMATIC MINI RANDOM ORBITAL SANDER, 63-PIECE

Suitable for small-scale repairs, particularly in hard-to-reach places.
Special features:

- ▶ Max. 15,000 revolutions per minute
- ▶ Rear exhaust through the handle
- ▶ Includes 6.3 mm (1/4") pneumatic connector

The set contains the following components:

- ▶ 1x mini pneumatic random orbital sander
- ▶ 2x Velcro pad holder, Ø 50 mm (2") and Ø 75 mm (3")
- ▶ 10 of each of the following sandpaper grades: 320/400/600, all with a diameter of 50 mm
- ▶ 10 of each of the following sandpaper grades: 320/400/600, all with a diameter of 75 mm



S3293 139,90 EUR*

NEEDLE SCALER ATTACHMENT

The needle scaler attachment is used for the removal of coatings on solid metal parts. With the metal needles it is the perfect tool to get rust off rims, frame parts or iron fences. Additionally you easily are able to remove paint, plastering or cement.

The needle scaler is an attachment to pneumatic chippings from sets S3211 and S3213.

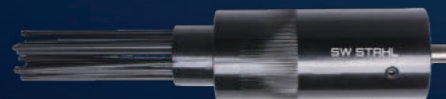

S3215 28,50 EUR*

POLISH SPONGE PAD 90 MM, 5 PIECES

suitable for use with mini air polisher S3292.

- ▶ Strength: hard
- ▶ Diameter 90 mm



S3292-H 47,50 EUR*

POLISH SPONGE PAD 90 MM, 5 PIECES

suitable for use with mini air polisher S3292.

- ▶ Strength: medium
- ▶ Diameter 90 mm



S3292-M 47,50 EUR*

POLISH SPONGE PAD 90 MM, 5 PIECES

suitable for use with mini air polisher S3292.

- ▶ Strength: soft
- ▶ Diameter 90 mm

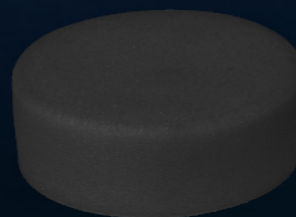

S3292-W 47,50 EUR*

CUTTING WHEEL, 50 MM



S3294-T 16,90 EUR*

ROUGHING DISC, DIAMETER 50 MM / GRIT 80



S3294-80 24,90 EUR*

BUFFING PAD Ø 90, 5 PIECES

Suitable for use with the mini pneumatic polishing grinder S3292. Buffing pad made of 100% wool for a shiny finish. With a diameter of 90 mm, the buffing pad is also suitable for smaller polishing machines. Attached using Velcro. Washable.



S3292-L 66,50 EUR*

PRESSURE REGULATOR, DIGITAL, 0.2-11 BAR

with digital display, for compressors.

- ▶ Continually adjustable from 0.2 - 11 bar
- ▶ Protects pneumatic tools by reducing compressor pressure
- ▶ Can be attached to the tool or air distributor / compressor



25048L 44,90 EUR*

PNEUMATIC HELICAL HOSE, 10 M

with nickel-plated quick couplings.

- ▶ Internal hose diameter: 10 mm
- ▶ External hose diameter: 14 mm
- ▶ Total length (extended): 10 m
- ▶ Material: Polyurethane
- ▶ Working pressure: 6.9 bar / 100 psi
- ▶ Bursting pressure: 20.7 bar / 300 psi
- ▶ Connecting thread: 10 mm (3/8")



25051L 29,90 EUR*

PNEUMATIC SANDBLASTING GUN

- ▶ Heavy-duty ABS housing
- ▶ Blasting sand tank capacity 600 cm³
- ▶ For use with regular aluminium oxide grit F46 to F100
- ▶ 5 mm steel tip



25070L 39,90 EUR*

PNEUMATIC SANDBLASTING GUN, 6-PIECE

Ideal for numerous applications on vehicle bodies and all metallic surfaces. For the removal of old paint, rust, heavy soiling.

- ▶ Working pressure 4 - 12 bar
- ▶ Air consumption max. 350 l/min



25065L 39,90 EUR*

COMPRESSED AIR HOSE RECOILER, 15 M

Suitable for wall and ceiling mounting, PVC hose with adjustable hose stopper.

- ▶ Hose lockable at 0.1 m intervals when unreeled
- ▶ 0.5 m hose connector
- ▶ 15 m usable hose
- ▶ Complete with 1/4" quick couplings
- ▶ With automatic recoil mechanism
- ▶ Internal hose diameter: 12.5 mm
- ▶ External hose diameter: 18.8 mm



25061L 139,90 EUR*

COMPRESSED AIR HOSE DRUM, Ø 8 MM, 30 M

with 30 m compressed air hose.

- ▶ Inner diameter 8 mm
- ▶ Outer diameter 12 mm
- ▶ 6.3 mm (1/4") compressed air connection
- ▶ On platform rotatable through 360°



25047L 139,90 EUR*

CORDLESS IMPACT WRENCH, 1/2", 900 NM, 18V

The new, battery-operated impact driver from SW-Stahl combines high torque with the latest technology.

Special equipment:

- ▶ Maintenance-free brushless motor (30% more efficient than a brushed motor)
- ▶ Longer running time without any change in battery capacity
- ▶ 2x Li-Ion batteries, 18 V - 5 Ah
- ▶ Batteries with level indicator
- ▶ Bright LED illumination of the work environment; light goes off after 15 seconds of non-use



S3300 389,90 EUR*

HOT AIR BLOWER, 2,000 W

e.g. for removing residual adhesive, heating hoses, paint-stripping work etc. with different attachments.

- ▶ Power 2,000 Watts
- ▶ Stage 1: 350 °C / 300 l / min.
- ▶ Stage 2: 550 °C / 500 l / min.



62005SB 29,90 EUR*

THE WINNERS WITH EXTRA POWER



PROFESSIONAL TORQUE WRENCH, 1/2", 20-100 NM

- ▶ Calibrated torque wrench with certificate and serial number
- ▶ Accuracy of $\pm 4\%$
- ▶ For the controlled right tightening
- ▶ With reversible ratchet head
- ▶ Direct numerical display of the desired torque value
- ▶ Secure locking of the rotary handle by means of push-button
- ▶ Extra fine scale graduation
- ▶ Ergonomically designed 2-component handle
- ▶ Service-friendly as repair kits are available

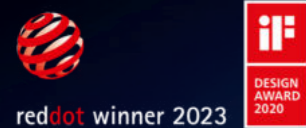

03873L 109,90 EUR*

PROFESSIONAL TORQUE WRENCH, 1/2", 40-200 NM

- ▶ Calibrated torque wrench with certificate and serial number
- ▶ Accuracy of $\pm 4\%$
- ▶ For the controlled right tightening
- ▶ With reversible ratchet head
- ▶ Direct numerical display of the desired torque value
- ▶ Secure locking of the rotary handle by means of push-button
- ▶ Extra fine scale graduation
- ▶ Ergonomically designed 2-component handle
- ▶ Service-friendly as repair kits are available

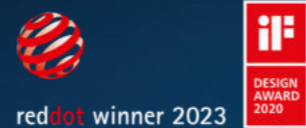

03874L 109,90 EUR*

PROFESSIONAL TORQUE WRENCH, 3/4", 150-750 NM

- ▶ Calibrated torque wrench with certificate and serial number
- ▶ Accuracy of $\pm 4\%$
- ▶ For the controlled right tightening
- ▶ With reversible ratchet head
- ▶ Direct numerical display of the desired torque value
- ▶ Secure locking of the rotary handle by means of push-button
- ▶ Extra fine scale graduation
- ▶ Ergonomically designed 2-component handle
- ▶ Service-friendly as repair kits are available



03877L 599,90 EUR*

PROFESSIONAL TORQUE WRENCH, 1", 200-1,000 NM

- ▶ Calibrated torque wrench with certificate and serial number
- ▶ Accuracy of $\pm 4\%$
- ▶ For the controlled right tightening
- ▶ With reversible ratchet head
- ▶ Direct numerical display of the desired torque value
- ▶ Secure locking of the rotary handle by means of push-button
- ▶ Extra fine scale graduation
- ▶ Ergonomically designed 2-component handle
- ▶ Service-friendly as repair kits are available

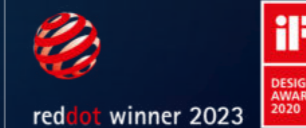

03878L 699,00 EUR*

PROFESSIONAL TORQUE WRENCH, 1/2", 60-340 NM

- ▶ Calibrated torque wrench with certificate and serial number
- ▶ Accuracy of $\pm 4\%$
- ▶ For the controlled right tightening
- ▶ With reversible ratchet head
- ▶ Direct numerical display of the desired torque value
- ▶ Secure locking of the rotary handle by means of push-button
- ▶ Extra fine scale graduation
- ▶ Ergonomically designed 2-component handle
- ▶ Service-friendly as repair kits are available

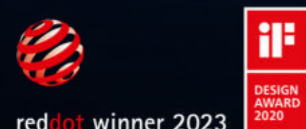

03875L 143,90 EUR*

PROFESSIONAL TORQUE WRENCH, 3/4", 110-550 NM

- ▶ Calibrated torque wrench with certificate and serial number
- ▶ Accuracy of $\pm 4\%$
- ▶ For the controlled right tightening
- ▶ With reversible ratchet head
- ▶ Direct numerical display of the desired torque value
- ▶ Secure locking of the rotary handle by means of push-button
- ▶ Extra fine scale graduation
- ▶ Ergonomically designed 2-component handle
- ▶ Service-friendly as repair kits are available

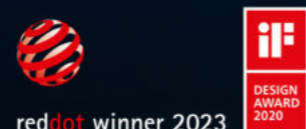

03876L 523,90 EUR*

PROFESSIONAL TORQUE WRENCH, 1/4", 5-25 NM

- ▶ Calibrated torque wrench with certificate and serial number
- ▶ Accuracy of $\pm 4\%$
- ▶ For the controlled right tightening
- ▶ With reversible ratchet head
- ▶ Direct numerical display of the desired torque value
- ▶ Secure locking of the rotary handle by means of push-button
- ▶ Extra fine scale graduation
- ▶ Ergonomically designed 2-component handle
- ▶ Service-friendly as repair kits are available

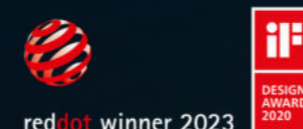

03871L 99,90 EUR*

PROFESSIONAL TORQUE WRENCH, 3/8", 10-50 NM

- ▶ Calibrated torque wrench with certificate and serial number
- ▶ Accuracy of $\pm 4\%$
- ▶ For the controlled right tightening
- ▶ With reversible ratchet head
- ▶ Direct numerical display of the desired torque value
- ▶ Secure locking of the rotary handle by means of push-button
- ▶ Extra fine scale graduation
- ▶ Ergonomically designed 2-component handle
- ▶ Service-friendly as repair kits are available

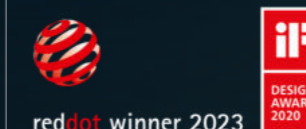

03872L 99,90 EUR*

PROFESSIONAL TORQUE WRENCH WITH RING WRENCH INSERTS AND REVERSIBLE RATCHET INSERT, 40-200 NM, 9-PIECE

- ▶ Calibrated torque wrench with calibration certificate and serial number
- ▶ 14 x 18 mm plug-in connection for plug-in tools
- ▶ Direct numerical display of the desired torque value

Content:

- ▶ Professional torque wrench with square insert, 14x18 mm, 40-200 Nm
- ▶ Reversible ratchet insert 12,5 mm (1/2")
- ▶ Ring wrench inserts with sizes 13, 15, 16, 17, 18, 19, 21 mm

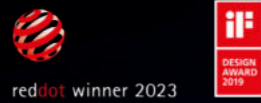

03880L 319,60 EUR*

PROFESSIONAL TORQUE WRENCH, WITH SQUARE INSERT, 40-200 NM

- ▶ 14 x 18 mm plug-in connection for insert tools
- ▶ Head can be replaced in seconds
- ▶ Calibrated torque wrench with calibration certificate and serial number
- ▶ Accuracy of ± 4%
- ▶ Direct numerical display of the desired torque value
- ▶ Secure locking of the rotary handle with a push button
- ▶ Extra fine scale graduation
- ▶ Ergonomically designed 2-component handle
- ▶ Service-friendly as repair kits are available
- ▶ Ergonomically designed handle
- ▶ Wide range of optionally available insert tools

DESIGNED
IN GERMANY

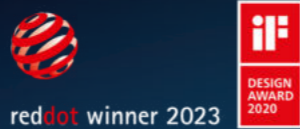

03870L 139,90 EUR*

GARAGE TORQUE WRENCH WITH WHEEL NUT SOCKETS, 1/2", 40-200 NM, 4-PIECE

- ▶ Calibrated torque wrench with certificate and serial number
- ▶ Accuracy of ± 4%
- ▶ For the controlled left and right tightening
- ▶ Ratchet head with push-through square (mushroom head)
- ▶ Clearly visible torque scale

Content:

- ▶ Garage torque wrench 12.5 mm (1/2"), 40-200 Nm
- ▶ Wheel nut sockets with sizes 17 mm, 19 mm and 21 mm

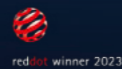

03879L 99,90 EUR*

GARAGE TORQUE WRENCH, 1/2", 40-200 NM

- ▶ Calibrated torque wrench with certificate and serial number
- ▶ Accuracy of ± 4%
- ▶ For the controlled left and right tightening
- ▶ Ratchet head with push-through square (mushroom head)
- ▶ Clearly visible torque scale
- ▶ Extra fine graduation (+/- 1 Nm)
- ▶ Secure locking of the rotary handle
- ▶ Ergonomically designed 2-component handle
- ▶ Service-friendly as repair kits are available

DESIGNED
IN GERMANY



03884L 99,90 EUR*

TORQUE WRENCH, 3/4", 140-700 NM

- ▶ Switchable
- ▶ Set value can be locked



03941L-IMP 339,90 EUR*

T-HANDLE TORQUE WRENCH WITH BITS, 2-8 NM, 13-PIECE

- ▶ Ideal for tightening with low torque
- ▶ Adjustment range: 2-8 Nm, in 0.1 Nm increments
- ▶ Easily legible scale
- ▶ 3/4" hexagonal drive
- ▶ Magnetic function
- ▶ With handy plastic handle

Scope of delivery:

- ▶ T-handle torque wrench, 2-8 Nm
- ▶ 12 bits



03913L 82,90 EUR*

GARAGE TORQUE WRENCH, 1/2", 60-340 NM

- ▶ Calibrated torque wrench with certificate and serial number
- ▶ Accuracy of ± 4%
- ▶ For the controlled left and right tightening
- ▶ Ratchet head with push-through square (mushroom head)
- ▶ Clearly visible torque scale
- ▶ Extra fine graduation (+/- 1 Nm)
- ▶ Secure locking of the rotary handle
- ▶ Ergonomically designed 2-component handle
- ▶ Service-friendly as repair kits are available

DESIGNED
IN GERMANY



03885L 129,90 EUR*

TORQUE REPRODUCER, 1", 3,200 NM, 5-PIECE

to release jammed wheel nuts on lorries and vans. 25 mm (1"), input and output with extension, crank and inserts 32, 33 mm. Transferrable torque: 3,200 Nm Even completely jammed or rusted wheel nuts are loosened easily; the nut is then removed quickly or refitted using a crank and extension.



03966L 164,90 EUR*

STETHOSCOPE, ELECTRONIC

for detecting mechanical damage to the engine, transmission and differential as well as noises such as creaking and squeaking on the bodywork

- ▶ Infinitely adjustable volume
- ▶ Incl. two 9V batteries
- ▶ With flexible shaft and highly sensitive microphone
- ▶ With 6-channel distributor and 6 sensors
- ▶ With 4.8 m connection cable



S3531 149,90 EUR*

ENGINE SUPPORT BAR, MAX. 250 KG

The universal engine support bar securely holds the engine from below as soon as the side engine mounts are dismantled. The usual engine bridge is no longer required. Provides free access from above when working on the toothed belt, water pump or auxiliary drive.

Dimensions:

- ▶ Maximum support load: 250 kg
- ▶ Variable length from 374 mm to 1170 mm
- ▶ Telescopic arm: extendable to 230 mm
- ▶ Support arms: rotatable by 360°, 122 mm long holes



26597L 579,90 EUR*

THREAD TAPPING SET, SPARK AND GLOW PLUGS, 7-PIECE

M8, M10, M12, M14, M16



03669L 169,90 EUR*

REMOVAL KIT GLOW PLUG ELECTRODE, 11-PIECE

For the quick removal of snapped glow plug electrodes without removing the cylinder head. Fits all common glow plug sizes.
Contents:

- ▶ 4 guide sleeves, M8x1.0, M9x1.0, M10x1.0 and M10x1.25
- ▶ 2 twist drills with extension, Ø2.5 mm and Ø3.2 mm
- ▶ 2 taps with extension, M3x0.5 and M4x0.7
- ▶ 2 removal rods, M3x0.5 and M4x0.7
- ▶ 1 bearing



03719L 349,90 EUR*

ARRESTER KEY

for crankshaft pulley when loosening and tightening the central screw on VW 1.6l engines
VW Bora, Golf, Lupo, New Beetle, Polo, Caddy
Seat Ibiza, Cordoba
Engine codes: ARC, ATN, AUS, AVY, AZD, BCB



10584L 69,90 EUR*

CRANKSHAFT COUNTERHOLDER FOR OPEL 1.0 / 1.2 / 1.4 L ECOFLEX

For holding the crankshaft pulley and for releasing the central fixing screw. With the handle included, the counterholder can be extended by 65 cm, thus offering the possibility of releasing fixed screwed connections. An additional ½" drive on the anvil alternatively allows use with a sliding handle.
Suitable for Opel Adam, Astra J, Cascada, Corsa D, Insignia, Meriva B, Mokka, Zafira C with 1.0 / 1.2 / 1.4 l ecoFlex engines.



10566L 179,90 EUR*

ENGINE ADJUSTMENT TOOL SET, FORD

suitable for 1.0 l EcoBoost 3-cylinder petrol engines from 2012 in the following vehicles: Ford: B-Max, C-Max, Fiesta, Ecosport, Focus, Grand C-Max, Transit Courier, Transit Connect, Tourneo Connect
Engine codes:

M1CA, M1CB, M1DA, M1DC, M1DD, M1DH, M1JA, M1JC, M1JE, M1JH, M1JJ, M1JL, M1JM, M2DA, M2DB, M2DC, M2GA, M2GB, P4JA, P4JB, P4JC, P4JD, Q0JA, Q0JB, Q0JC, Q0JD, SFCA, SFCB, SFCC, SFCD, SFDA, SFDB, SFJA, SFJB, SFJC, SFJD, SFJE, SFJF, SFJH, SFJJ, SFJK, SFJL, SFJN, SFJP, XMJA, XMJB, YYJA, YYJB, YYJC, YYJD, YYJE

Used equivalent to the following OE numbers:

- ▶ Rig pin 303-732
- ▶ Timing belt tensioner locking pin 303-1054
- ▶ Flywheel retainer tool 303-1602
- ▶ Sealing ring installation tool 303-1603
- ▶ Crankshaft setting pin 303-1604
- ▶ Camshaft retainer tool 303-1605
- ▶ Arrester tool 303-1606
- ▶ Sealing ring installation tool 303-1636
- ▶ Peg T10060A



26175L 276,90 EUR*

REMOVAL AND ASSEMBLY SET RETURN SPRING, CITROËN/ MINI/ PEUGEOT

Special tool for assembling and disassembling the return spring on the intermediate lever on Citroën, Mini, Peugeot vehicles with variable valve timing.

Engine Codes:

- ▶ Mini N12, N16, N18
- ▶ Citroën / Peugeot: EP3, EP3C, EP6, EP6C

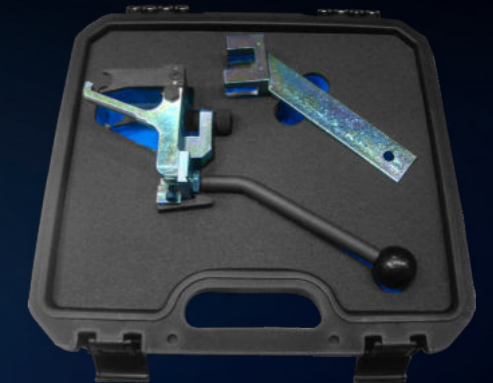

26302L 299,90 EUR*

TORQUE REPRODUCER, FORD

for loosening and tightening the central fastening screw of the crankshaft pulley. The torque multiplier has a transmission ratio of 1:5.

The tool is essential when working on the following Ford engines: 1.0 EcoBoost, 1.0 Duratec, 1.1 Duratec, 2.0 Duratorq-TDCi, 2.0 EcoBlue Diesel

Suitable for the following vehicles: B-Max 01/12-, C-Max 04/10-, Ecosport 05/12-, Fiesta 05/12-, Focus 01/18-, Mondeo 10/14-, Transit Connect 02/13-, Transit 08/13-

To be used with the following OE numbers: 303-1611, 303-1611-01, 303-1611-02



26189L 459,90 EUR*

REMOVAL AND ASSEMBLY SET RETURN SPRING, BMW

for assembly and disassembly of intermediate lever compression springs on BMW vehicles with variable valve timing.

Engine codes: N13, N20, N26, N52, N55



26195L 223,90 EUR*

SPARK PLUG CONNECTOR PLIER

with strong insulated handles. Also suitable for pulling off injection lines



40901L 13,90 EUR*

REFILLING PUMP, 500 CCM

Metal version, including 2 hoses for intake and outlet, 500 cm³. The ball valve clearly separates the suction and pressure stroke.

Suitable for:

- ▶ Petrol, diesel, heating oil
- ▶ Coolant, petroleum ether
- ▶ Brake fluid and oils
- ▶ Hose diameter inside: 9 mm / outside: 12 mm
- ▶ Hoses each 1150 mm long



24025L 29,90 EUR*

BRAKE LINE SPANNER SET, 6-PIECE

Chrome-vanadium, with flexible joints, in plastic folding box, also ideal for screw attachment systems, hydraulic and brake lines, power steering etc.

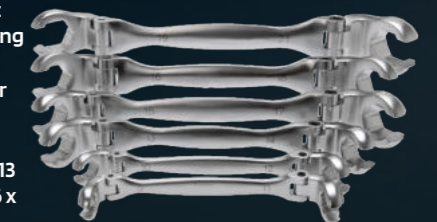

9 x 11 mm, 10 x 12 mm, 13 x 14 mm, 15 x 17 mm, 16 x 18 mm, 19 x 21 mm

01488L 89,90 EUR*

LINE CONNECTOR RELEASE SET, UNIVERSAL, 22-PIECE

For opening line couplings in air conditioning systems, and fuel, air and oil lines with a diameter of 5/16", 3/8", 1/2", 5/8", 3/4", 7/8". Universal assortment - suitable for all common vehicles.



61717L 49,90 EUR*

HOSE CLAMP PLIERS SET, 3-PIECE

e.g. for brake, petrol, coolant pipes etc., resistant to oil and acids, with catch closure.

- ▶ 150 mm for diameters up to 15 mm
- ▶ 180 mm for diameters up to 30 mm
- ▶ 250 mm for diameters up to 60 mm

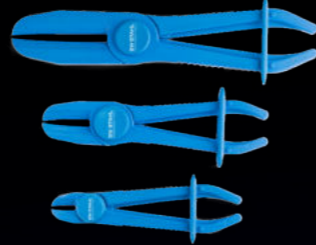

61705L 10,50 EUR*

HOSE CLAMPS ASSEMBLY TOOL, VAG

Suitable for releasing pretensioned spring band clamps when installing coolant hoses on numerous vehicles from the VAG Group. There are various lifting points on the tool so that it can even be used in confined installation spaces.

To be used in the same way as the part with OE number VAS 531 001.



94812L 21,90 EUR*

THREAD CUTTING TOOL SET, 9-PIECE

ideal for the professional repair and maintenance of the threads of, for example, drive shafts, lambda probes, wheel studs, connecting pieces of the gas and liquid lines of cooling and gas systems as well as of hydraulic systems. The thread size of the individual chasers is marked separately and can therefore be used to measure and determine thread sizes.

- ▶ For reground and cleaning of external and internal threads
- ▶ Drive takes place via supplied turning rod or socket
- ▶ Included sizes: M14 x 1.5 - M16 x 1.5 - M18 x 1.5 - M20 x 1.5 - M22 x 1.5 - M24 x 1.5 - M27 x 2.0 - M28 x 1.5
- ▶ In plastic case



82240L 69,90 EUR*

RADIATOR PRESSURE TEST ADAPTER, 4-PIECE

Suitable for universal use, for pressure testing the cooling system. For quickly locating leaks in the cooling circuit.

- ▶ Anodised aluminium
- ▶ Radiator pressure tester for inner diameters 30 - 35 mm
- ▶ Additional rubber rings can increase the diameter up to 50 mm
- ▶ Includes rubber rings with diameters of 35-40 mm, 40-45 mm and 45-50 mm

Compatible with 21000L, 21001L, 21030L and 21040L!



21053L 59,90 EUR*

OIL SERVICE KEY SET, UNIVERSAL, 12-PIECE

For universal use in the passenger car sector, 10 mm (3/8") drive.

- ▶ Hexagon 8 - 9 - 10 - 12 - 14 - 17 mm + 10 mm (3/8")
- ▶ Square 8 - 11 - 13 mm + 10 mm (3/8")
- ▶ 1 sliding handle



03015L 35,90 EUR*

OIL PUMP, 200 CCM

Ideal for filling, evacuating or dosing for gears, power steering, hydraulics, engine etc.

- ▶ 200 cm³ (0.2 l) per stroke
- ▶ Hose length ca. 300 mm, 8 mm diameter
- ▶ Metal version



24015L 18,90 EUR*

SUCTION PUMP, ELECTRICAL

For extracting diesel oil, heating oil or engine oil.

- ▶ Operation via 12 V car battery using crocodile clamps
- ▶ Engine oil delivery rate: 0.2 l/min
- ▶ Diesel oil/heating oil delivery rate: approx. 70 l/h
- ▶ The oil is extracted through the guide tube of the dipstick shaft using a continuous oil extraction probe with a diameter of 6 mm

The pump is not suitable for pumping out water, gearbox oil or highly flammable liquids.



08485L 41,90 EUR*

OIL FILTER BELL SET, 23-PIECE

made of light alloy, with 12.5 mm (1/2") drive and 27 mm outer hexagon and loosening key.

- ▶ 1 ratchet wrench 12.5 mm (1/2")
- ▶ 1 ring spanner 27 mm
- ▶ 21 oil filter bells:



08450L 149,90 EUR*

BARREL PUMP

- ▶ For oil, antifreeze etc. (not suitable for fuel)
- ▶ Suitable for barrels with a volume of up to 200 litres, 2" NPT threaded receptacle
- ▶ Pumps approx. 150 ml per stroke
- ▶ Telescopic pipe extends from 450 to 860 mm



24016L 59,40 EUR*

EXTRACTION PUMP, 9,5 L

For manual or pneumatic operation with 9.5 l tank, ideal for bleeding brakes and for oil extraction, suitable for day-to-day workshop use



24035L 229,90 EUR*

FILTER LOOSENING KEY, 60-80 MM

Suitable for universal use; can be used with socket spanner size 21 as well as with a 12.5 mm (1/2") ratchet. Optimum hold and interlock is given through stable self-clamping attachment and the toothed cheeks. Clockwise and anti-clockwise operation, thus suitable for loosening and tightening.



08411L 69,90 EUR*

AIR CONDITIONER RELEASE TOOL, VAG, 2-PIECE

- ▶ For releasing the quick couplings on air conditioning lines
- ▶ Suitable for VW, Audi, Skoda, Seat
- ▶ Closed size: 16 / 18 mm
- ▶ Used equivalent to OEM T40149



61800L 43,90 EUR*

EXHAUST CHAIN PIPE CUTTER, STAINLESS STEEL, 35-85 MM

for stainless steel pipes 35 - 85 mm, easier work through automatic clamping device.



10540L 116,90 EUR*

WISHBONE LEVER TOOL

Facilitates the removal of wishbones from the wheel bearing housing. Also very useful when installing prestressed wishbones. The lever tool is attached to the vehicle floor and the wishbone using strong metal hooks attached to chains. Rotating the spindle exerts a tensile force on the wishbone.



10048L 179,90 EUR*

BALL-JOINT EXTRACTOR, MERCEDES-BENZ

For pressing out the suspension joint from the steering knuckle for Mercedes-Benz Sprinter and VW LT.



302403L 319,90 EUR*

TURBO SYSTEM FORCE-OFF SET, 13-PIECE

For fast diagnosis on the charging air system. Professional time-saving troubleshooting e.g. detecting leaks in the intercooler or invisible cracks in the charge air hoses. Multi-size adapter makes it suitable for all hoses commonly used in the charge air system. Pressure can be exerted on the part to be tested through a tyre pressure valve with conventional tyre filler (with excess pressure safety valve). 6 adapters with counterplugs each for the sizes:

- ▶ 31 / 38 mm
- ▶ 46 / 51 mm
- ▶ 55 / 60 mm
- ▶ 65 / 70 mm
- ▶ 75 / 80 mm
- ▶ 85 / 90 mm



26200L 239,90 EUR*

BEARING AND BUSH REMOVAL/INSERTION SET, 32-PIECE

For the removal and insertion of suspension bushes, ball bearings, wheel bearings, rubber bearings, etc. to passenger cars and commercial vehicles. Also to be used for radial sealing rings.

- ▶ Four spindles in 350 mm length, M10, M12, M14 and M16
- ▶ Eight pressure nuts with bearing: M10, M12, M14, M16
- ▶ 20 pressure pieces with various dimensions, slotted for visual inspection



10043L 249,90 EUR*

SUPPORTING JOINT TOOL, 6-PIECE

For removing and installing the outer supporting joints without dismantling the steering knuckle in Mercedes-Benz E / S / SL class (W220/ W211/W230).

- ▶ 2 pressure pieces
- ▶ Inner diameter 47 mm, outer diameter 57 mm
- ▶ Inner diameter 23 mm, outer diameter 33 mm
- ▶ 2 ferrules
- ▶ Inner diameter 39 mm
- ▶ Inner diameter 53 mm
- ▶ With 185 mm pressure spindle
- ▶ 24 mm hex drive



10009L 273,90 EUR*

SET OF FITTING WASHERS, 52-PIECE

Suitable for fitting bearing shells, sealing rings and rubber seals. Particularly helpful when used with hydraulic presses. Contains thrust washers in sizes 18 - 65 mm (in 1 mm increments) and 74 mm, as well as a 220 mm x Ø 12 mm metal grab handle for assembly using hammers. All washers from size 34 mm have an inner diameter of 21 mm.



10341L 249,90 EUR*

BEARING AND SEALING RING MOUNTING SET

For installing bearing rings and taper roller bearings so that they are aligned and centred. The set includes one impact mandrel and various pressure discs with the following outer diameters: 40 - 44 - 50 - 59 - 63 - 65 - 72 - 76 - 81 mm. Made of solid aluminium, CNC turned with maximum fitting accuracy.



10140L 87,90 EUR*

FORK BALL JOINT SEPARATOR, FORK TYP 18 MM

Medium sized fork ball joint breaker, internal jaw size 18 mm for small to medium sized ball joints.



10101L 34,90 EUR*

PRY BAR SET, 4-PIECE

Pry bar for all applications in the truck and agricultural vehicles sector. With plastic soft grip, single-piece blade and impact cap. Ideal for supporting joints, bearing and separating work. High-strength version.

- ▶ 900 mm straight
- ▶ 900 mm 45° angled
- ▶ 600 mm 75° angled
- ▶ 600 mm 90° angled



10104L 179,90 EUR*

WHEEL BEARING TOOL SET, VAG, 16-PIECE

Includes spindle and thrust bearing, for damage-free installation and removal of bearing/hub units with a diameter of 72 mm on vehicles such as the following:

- ▶ VW: Polo 9N / 6R, Fox 5Z, etc.
- ▶ Seat: Ibiza 6L / 6J, Toledo, etc.
- ▶ Audi: A1 8X, A2 8Z, etc.
- ▶ Škoda: Fabia 6Y / 5J, roomster 5J, etc.



301050L 419,90 EUR*

AXLE BELLOWS PLIERS, 3/8", 8-PIECE

- ▶ For mounting stainless steel tensioning straps with prescribed torque
- ▶ Straight clamping jaws for clamping and parallel pressing of the pipe clamps
- ▶ 90° angled clamping jaws for lateral clamping and parallel pressing of the pipe clamps
- ▶ Ideal for cramped spaces
- ▶ With 3/8" drive for torque wrench

- Contents:**
- ▶ Axle boot pliers
 - ▶ 2x straight jaws
 - ▶ 2x 90° angled jaws
 - ▶ 2x fastening bolt
 - ▶ Internal hexagon wrench



61782L 138,90 EUR*

WHEEL ALIGNMENT WRENCH, MERCEDES-BENZ

Facilitates wheel alignment on the rear axle.

- ▶ Includes two interchangeable multi-toothed bits, sizes M10 and M12
- ▶ Makes it easy to reach and remove difficult-to-reach adjustment screws
- ▶ For Mercedes-Benz C-Class (C 203) and S-Class, as well as for older models with underbody cladding and vehicles with fill level sensors



302353L 34,50 EUR*

SPRING TENSIONER SET, 3-PIECE

universal, makes one-hundred percent spring cover and thus maximum safety possible.

- ▶ Clamping range to 240 mm

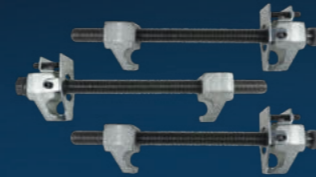

10250L 109,90 EUR*

SHOCK ABSORBER FITTING TOOL SET, 6-PIECE

For fitting and removing shock absorbers with a buffer spring. For BMW, Fiat, Ford, Mercedes-Benz, Nissan, Peugeot, Toyota, and so on



10276L 199,90 EUR*

TELESCOPIC SPRING TENSIONER

for Mercedes-Benz vehicles of the series: 116 - 123 - 124 - 126 - 129 - 140 - 170 - 201 - 202 - 208 - 210. The short design of the inner tensioner makes fast work possible even under cramped conditions. The telescopic body allows stepless adjustment to the respective spring length. With two pairs of clamping lugs for spring diameters 80 - 119 mm and 89 - 141 mm



10210L 479,90 EUR*

SHOCK ABSORBER TOOL SET, 18-PIECE

For professionally loosening and tightening the shock absorber nuts on the suspension strut bearing. Suitable for all common vehicles.

- ▶ Open reversible ratchet with 21 mm bi-hexagon bit
- ▶ 7 open hexagon bits 16 - 17 - 18 - 19 - 21 - 22 - 24 mm
- ▶ 10 counter holder bits with 12.5 mm (1/2") socket, 122 mm long:
- ▶ Inner hexagon sockets 6 - 7 - 8 mm
- ▶ T-profile T50
- ▶ Special oval bits 5 x 8 - 6 x 8 - 7,1 x 9,6 mm
- ▶ Hexagon bit socket 7 - 8 - 9 mm



10365L 219,90 EUR*

CAMBER SPIRIT LEVEL

- ▶ Allows replacement of the strut without subsequent camber measurement, thereby saving a huge amount of time
- ▶ The meter is attached to the brake disc or wheel hub using the magnetic side and the measurement read off
- ▶ After repairs are complete, the camber is reset to the previous measured value



10240L 85,90 EUR*

TELESCOPIC SPRING TENSIONER, VAG, 9-PIECE

Technical data:

- ▶ Spring seats with a diameter of approx. 75-140 mm
- ▶ Clamping range 95-220 mm / max. clamping force 1600 kg

Benefits:

- ▶ Additional safeguard to prevent the spring seats from being unscrewed
- ▶ For access holes, min. diameter 30 mm
- ▶ Torsion rod for overload protection
- ▶ Spindle cannot collide with car body
- ▶ Springs can be removed without dismantling the axle



10212L 348,90 EUR*

SPREADING TOOL, 7-PIECE

with 2 exchangeable spreading inserts (5 and 8 mm deep) for different splay angles and guide bolt (8, 10 and 12 mm) e.g. for the shock-absorber seat on the wheel bearing housing during shock-absorber replacement, ball-and-socket joint seat at the wishbone/A-frame arm during removal of the suspension strut etc.



10305L 69,90 EUR*

WHEEL NUT WRENCH, 24 X 27 MM

based on DIN 3119

- ▶ extremely stable design made from high-quality chrome vanadium
- ▶ with 22 mm turning pin (length 600 mm)
- ▶ matt chrome plated
- ▶ in practical fabric bag



02245L 47,00 EUR*

WHEEL NUT WRENCH, 27 X 32 MM

based on DIN 3119

- ▶ Extremely stable design made from high-quality chrome vanadium
- ▶ With 22 mm turning pin (length 600 mm)
- ▶ Matt chrome plated
- ▶ In practical fabric bag



02247L 47,50 EUR*

WHEEL NUT WRENCH, 1/2", 17-19-21 MM

- ▶ With reinforced central plate
- ▶ Leg length 170 mm



02100L 17,90 EUR*

WHEEL NUT WRENCH, 3/4", 24-27-32 MM, TRUCKS

- ▶ With reinforced central plate
- ▶ Leg length 350 mm



02450L 47,90 EUR*

WHEEL NUT WRENCH, 30 X 32 MM

based on DIN 3119

- ▶ Extremely stable design made from high-quality chrome vanadium
- ▶ With 22 mm turning pin (length 600 mm)
- ▶ Matt chrome plated
- ▶ In practical fabric bag



02251L 47,50 EUR*

CROSS BAR FOR WHEEL NUT WRENCHES, 600 MM

for wheel nut wrenches

- ▶ diameter 22 mm
- ▶ length 600 mm
- ▶ made of high-quality chrome vanadium steel



02242L 22,60 EUR*

WHEEL NUT SOCKETS, 1/2", 17-21 MM, 3-PIECE

- ▶ Fully plastic-encapsulated
- ▶ Extra thin-walled
- ▶ Optimum power transmission

17 mm, 19 mm, 21 mm



07870L 24,90 EUR*

WHEEL NUT SOCKETS, 1/2", 15-22 MM, 5-PIECE

- ▶ Fully encapsulated in plastic
- ▶ Extra thin walls
- ▶ Optimum force transmission

15, 17, 19, 21, 22 mm



07865L 39,90 EUR*

WHEEL NUT WRENCH, 24 X 27 MM

based on DIN 3119

- ▶ extremely stable design made of high-quality chrome vanadium steel.
- ▶ mat chrome-plated.



02220L 19,90 EUR*

WHEEL NUT WRENCH, 27 X 32 MM

based on DIN 3119

- ▶ extremely stable design made of high-quality chrome vanadium steel
- ▶ mat chrome-plated



02222L 20,50 EUR*

WHEEL NUT SOCKET, 1/2", 17 MM, DEEP

Especially for Mercedes-Benz.

- ▶ Impact-resistant
- ▶ Star profile
- ▶ Fully plastic encapsulated
- ▶ Optimum force transmission
- ▶ Protects against scratches on rims



07887L 12,90 EUR*

WHEEL NUT SOCKET, 1/2", 21 MM, LONG

Suitable e.g. for Hyundai and Kia.

- ▶ Impact-resistant
- ▶ Star profile
- ▶ Fully plastic encapsulated
- ▶ Optimum force transmission
- ▶ Protects against scratches on rims



07888SB 12,90 EUR*

WHEEL NUT WRENCH, 30 X 32 MM

based on DIN 3119

- ▶ extremely stable design made of high-quality chrome vanadium steel
- ▶ mat chrome-plated

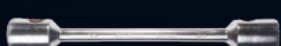

02226L 20,50 EUR*

WHEEL NUT KEY, EXTENDABLE, 17 AND 19 MM

Interchangeable, extendable from 370 to 530 mm.



02105SB 15,50 EUR*

WHEEL NUT SOCKET, 1/2", 15 MM

- ▶ Fully plastic encapsulated
- ▶ Extra thin walled
- ▶ Impact-resistant
- ▶ Optimum force transmission
- ▶ Rims and bolts will no longer get scratched
- ▶ Made of high-strength chrome molybdenum steel



07878L 11,90 EUR*

WHEEL NUT SOCKET, 1/2", 22 MM

- ▶ Impact-resistant
- ▶ Fully plastic encapsulated
- ▶ Extra thin walled
- ▶ Optimum force transmission
- ▶ Rims and bolts will no longer get scratched
- ▶ Made of high-strength chrome molybdenum steel

E.g. for Opel/Vauxhall Insignia, Saab 9-5 II, Toyota Land Cruiser.



07879L 12,90 EUR*

WHEEL NUT SOCKETS, 1/2", 17-21 MM, 3-PIECE, LONG

Special length, especially suitable for well-base rims.

- ▶ Fully plastic encapsulated
- ▶ Extra thin walled
- ▶ Optimum force transmission
- ▶ Impact-resistant

17 mm, 19 mm, 21 mm



07880L 69,90 EUR*

SPIRAL GROOVE SOCKETS, 1/2", 17-19-21 MM, 4-PIECE

For releasing badly damaged wheel nuts and bolts.

- ▶ 150 mm sockets
- ▶ Sizes 17, 19, 21 mm
- ▶ Removal pin



07890L 98,90 EUR*

STUD BOLT THREAD REPAIR KIT, 6-PIECE

for re-cutting or cleaning stud bolts or screws. The cutting jaws can be separated to place the tool on an undamaged thread section.

- ▶ M12 x 1.25
- ▶ M12 x 1.50
- ▶ M14 x 1.50



02371L 44,50 EUR*

THREAD TAPPING SET FOR WHEEL BOLTS AND STUDS, 12-PIECE

For cleaning and rethreading wheel bolts, threaded holes and studs on the wheel hub.

- ▶ M12 x 1.25 mm
- ▶ M12 x 1.50 mm
- ▶ M14 x 1.50 mm



02370L 139,90 EUR*

WHEEL LOCK REMOVAL TOOL, 10-PIECE

Allows wheel locks to be removed quickly and easily. The tapered sleeves are hammered onto the lock and can then be released with a wheel nut spanner. The lock is NOT DAMAGED in this process.

- ▶ 8 sleeves from 16.8 - 25.8 mm



02380L 79,90 EUR*

WHEEL LOCK NUT SET, VW, 23-PIECE

Replacement key for original wheel locks when the original key is no longer available or forgotten when changing the wheel. The key set allows the original lock nuts to be released and tightened without damage. Suitable for vehicles up to 2012. Includes the following sizes: 51/6PT; 52/7PT; 53/8PT; 54/9PT; 55/10PT; 56/11PT; 57/12PT 58/13PT; 59/14PT; 60/15PT; 61/16P; 62/17PT; ABC0/10PT; ABC1/11PT; ABC2/13PT; ABC3/14PT; ABC4/15PT; ABC5/16PT; ABC6/17PT; ABC7/19PT; ABC8/20PT; ABC9/21PT
Wheel lock socket, 17mm x 85mm, 12,5 mm (1/2") drive



02382L 99,90 EUR*

PNEUMATIC TYRE FILLER, 0-10 BAR

- ▶ Calibrated version according to guideline 86/217/EWG
- ▶ Rubber-sheathed gauge
- ▶ With flexible 400 mm hose
- ▶ Measuring / filling range 0 - 10 bar



25032L 61,90 EUR*

PNEUMATIC TYRE FILLER, 0-10 BAR

European make, calibrated version according to Directive 86/217/EEC.

- ▶ Measuring/filling range 0 - 10 bar
- ▶ Rubber-encased gauge
- ▶ Length of filling hose approx. 530 mm
- ▶ Scale diameter 56 mm (visible)



25034L 79,90 EUR*

LOCKING WHEEL NUT KEY SET, VW, 20-PIECE

Replacement keys for original wheel locks. Set allows the original lock nuts to be released and tightened without damage. Suitable for vehicles produced since 2012.



02383L 199,90 EUR*

WHEEL LOCK REMOVER SET, MERCEDES-BENZ, 30-PIECE

Replacement keys for original wheel locks; set allows the original lock nuts to be released and tightened without damage. Suitable for vehicles produced since 2012.



02385L 279,90 EUR*

TYRE PRESSURE SENSOR TOOL SET, 14-PIECE

Suitable for TPMS, for mounting and disassembling tyre pressure control systems. Includes:

- ▶ Torque spanner 6.3 mm (1/4") 2-10 Nm, pitch 0.5 Nm, fine scale 0.1 Nm for fastening the metal valve to the rim
- ▶ Torque screwdriver 1.4 Nm with 4 mm hexagon socket for mounting the RDC sensor on the valve
- ▶ Valve sealing tool for damage-free mounting and dismantling of rubber seals on TPMS valves
- ▶ Torque-limited valve screwdriver 0.25 Nm and 0.45 Nm
- ▶ Pin punch for bracing
- ▶ Long bit 11 mm and 12 mm
- ▶ Screwdriver bits T10, T15, T20



02129L 229,90 EUR*

VALVE LATHE TOOL FOR STEEL VALVES

eases the installation and removal of steel valves, e.g. on alloy wheels, rims on transporters and mobile homes (the manufacturers recommend the use of steel valves to prevent pressure loss here).

- ▶ With guide pins - prevents slipping off
- ▶ Tightening feasible with torque wrench



02112L 6,90 EUR*

WHEEL LOCK NUT SET, BMW, 21-PIECE

Replacement key for original wheel locks when the original key is no longer available or forgotten when changing the wheel. The key set allows the original lock nuts to be released and tightened without damage. Suitable for vehicles up to 2012



02381L 139,90 EUR*

WHEEL LOCK REMOVER SET, BMW, 20-PIECE

Replacement keys for original wheel locks, allows the original lock nuts to be released and tightened without damage. Suitable for vehicles produced since 2012.



02384L 199,90 EUR*

UNIVERSAL BALANCE WEIGHT PLIERS, 245 MM

For loosening lead weights on rims. Chrome-plated, handles insulated



47440L 26,90 EUR*

STRIPE OFF WHEEL, 90 MM

For fitting to drills.

- ▶ Ideal for fully removing adhesive residues left behind by the removal of adhesive balancing weights.
- ▶ 6 mm adapter with threaded connection 5/16" x 24
- ▶ Disc size: 90 x 15 mm
- ▶ Speed: max. 4,000 rpm



94857L 9,99 EUR*

STRIPE OFF WHEEL, M8

with M8 thread

- ▶ Wheel circumference: 90 x 15 mm
- ▶ Speed: max. 4,000 rpm



94858L 5,99 EUR*

TYRE BEAD CLAMP

- ▶ With replaceable protection
- ▶ For damage-free tyre fitting on aluminium rims
- ▶ The plastic top cover is fastened on the steel core by using 3 screws



02180L 27,90 EUR*

TAPE MEASURE, METRIC, 3 M, 5 M, 8 M

- ▶ In robust 2-component housing with non-slip palm rest
- ▶ With belt clip
- ▶ With stopper and automatic return
- ▶ Magnetic end hook, movable for inside and outside measurement
- ▶ Accuracy class II
- ▶ With CE and metrology marking
- ▶ Complies with the MID directive valid for Europe



DESIGNED
IN GERMANY

3 M
72010L 7,90 EUR*

5 M
72020L 11,90 EUR*

8 M
72030L 13,90 EUR*

GLUED WEIGHT REMOVER

Professional version

- ▶ Almost indestructible
- ▶ Solvent-resistant
- ▶ Can be reground by means of file
- ▶ Surfaces are not damaged



94850L 8,90 EUR*

TYRE LEVER, 1,000 MM

- ▶ Special shape
- ▶ Heavy-duty version for commercial vehicles agricultural and construction machinery
- ▶ Chromium vanadium
- ▶ Length 1,000 mm



02163L 53,50 EUR*

TYRE LEVER, 380 MM

- ▶ With replaceable protection
- ▶ For damage-free tyre fitting on aluminium rims
- ▶ The plastic top cover is fastened on the steel core by using 3 screws

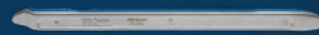

02158L 24,50 EUR*

TYRE LEVER, 390 MM

The length of 390 mm combined with the ergonomic handle reduces fatigue during the busy season, even if the tool is used continually.



02156L 19,90 EUR*

FITTING PASTE, 5 KG

for the fast, gentle and easy fitting and removal of all standard wheel/tyre combinations including run-flat tyres and PAX tyres.

- ▶ Chemically neutral to rubber and metal
- ▶ The high sliding effect during fitting and removal reduces fitting injuries
- ▶ Promotes the interlocking between rim and tyre
- ▶ 100% biologically degradable
- ▶ 100% guarantee of no contact allergies for fitters
- ▶ Antifreeze-safe, processing temperature from -15°C to +50°C
- ▶ Very efficient
- ▶ Centrifuge-resistant
- ▶ Color white



3 KG
02130L 17,90 EUR*

5 KG
02132L 15,90 EUR*

WHEEL HUB GRINDER REPLACEMENT CLEANING DISCS, SET OF 2

For wheel hub grinder 302230L. Corrosion between the rim and the wheel hub is removed and torque values can no longer be distorted.

- ▶ Inner diameter 90 mm
- ▶ Outer diameter 150 mm

Also suitable for the latest wheel hubs with an enlarged inner diameter, e.g. on: BMW 1 Series (E81, E82, E87, E88, F20, F21).

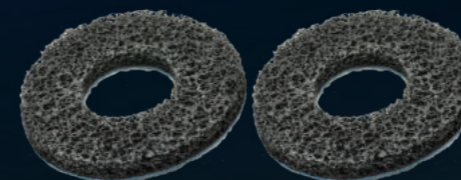

302230L-1 34,90 EUR*

BRUSH

With round head for better application of assembly paste.



02135L 26,15 EUR*

PRESSURE SPRAYER 360°, 1L

- ▶ Suitable for acetone-free brake cleaner, fuel and commercial cleaning agents
- ▶ Including adjustable spray nozzle



07384L 14,90 EUR*

ALUMINIUM WHEEL HUB CLEANER

Cleaning of wheel hubs and other flat surfaces. Removes corrosion on the contact surfaces between the wheel hub and rim.

- ▶ High-strength aluminium with steel core
- ▶ MADE IN GERMANY
- ▶ Extremely high impact resistance
- ▶ Extremely high abrasion and wear resistance
- ▶ Maximum speed of 4,000 rpm
- ▶ Sturdy Velcro fastener for quick change of grinding wheels



302230L 69,95 EUR*

WHEEL HUB CLEANER SET, 10-PIECE

suitable for wheel hubs with stud bolts.
Content:

- ▶ 1 base made of plastic, with hexagon
- ▶ 8 grinding wheels, each 40 mm in diameter
- ▶ 1 adapter 12,5 mm (1/2")



10359L 41,90 EUR*

BRUSH SET FOR DRILLING MACHINES, 4-PIECE

Content:

- ▶ Suitable for all indoor and outdoor cleaning projects
- ▶ Especially for rim cleaning
- ▶ 1/4" Holder for cordless drills
- ▶ Durable nylon bristles
- ▶ Brush attachment with diameter 4,9 cm
- ▶ Brush attachment with diameter 8,4 cm
- ▶ Brush attachment with diameter 10 cm
- ▶ Brush attachment with diameter 12 cm



62400L 15,90 EUR*

SPECIAL BRAKE CALLIPER BRUSH, STEEL WIRE

made of steel wire, with hook hole and ergonomically shaped handles.



09321L 6,50 EUR*

SPECIAL BRAKE CALLIPER BRUSH, BRASS

made of brass, with hook hole and ergonomically shaped handles.



09322L 10,50 EUR*

BOLT CLEANING SET, 1/2", 1/4", CAR, 8-PIECE

For quick and easy cleaning of screws, studs or wheel bolts.
The set includes the following brush attachments (1 each):

- ▶ Brush attachment 12 mm (7/16")
- ▶ Brush attachment 13 mm (1/2")
- ▶ Brush attachment 14 mm (9/16")
- ▶ Brush attachment 16 mm (5/8")
- ▶ Brush attachment 18 mm (45/64")
- ▶ Brush attachment 22 mm (55/64")
- ▶ Quick switch brush adapter 1/2"
- ▶ 1/2" to 1/4" adapter for use on a cordless screwdriver



10358L 61,50 EUR*

SPECIAL BRAKE CALLIPER BRUSH, 275 MM

made of steel wire, with hook hole.
In the case of stubborn soiling, please use our brake calliper file 94830L.



09300L 9,90 EUR*

SPECIAL BRAKE CALLIPER BRUSH, BRASS

made of brass, with hook hole.
Always required on all aluminium brake callipers to remove brake dust.
Also suitable for cleaning work on all sensitive, metallic surfaces.



09310L 12,90 EUR*

BOLT CLEANING SET, 1/4", LORRY, 4-PIECE

For quick and easy cleaning of screws, studs or wheel bolts.
The set includes the following brush attachments (1 each):

- ▶ Brush attachment 20 mm, 37 mm deep
- ▶ Brush attachment 22 mm, 60 mm deep
- ▶ Brush attachment 24 mm, 37 mm deep
- ▶ Brush attachment 30 mm, 60 mm deep

The brush attachments are also available separately!



10354L 156,90 EUR*

RATCHET BRAKE PIPE CUTTER

Allows quick and easy cutting of brake lines.

- ▶ For brakelines with a diameter of 4.75 mm
- ▶ With ratchet function
- ▶ With automatic self-adjustment
- ▶ Ideally suited for confined spaces



24522L 32,50 EUR*

BRAKE BLEEDING KEY SET, 4-PIECE

For bleeding hydraulic brake and clutch systems, suitable for all universal bleed nipples

- ▶ 3 special spanners, sizes: 7 / 8 / 9 / 10 / 11 and 12 mm
- ▶ Silicone tube with safety valve



HERE IT GOES TO THE VIDEO



01452L 94,90 EUR*

BRAKE BLEEDER ADAPTER SET, TESLA AND STANDARD EURO MODELS

- ▶ Adapter set for bleeding the brakes on vehicles with standard Euro threads
- ▶ Adapter for Tesla Model S and X, Tesla Model 3 and Y
- ▶ Metal adapter holds pressure up to 2.5 bar / 36 psi
- ▶ ...



01493L 139,90 EUR*

UNIVERSAL ADAPTER FOR BRAKE BLEEDING, CONNECTION 90° ANGLED

The infinitely adjustable clamping brackets allow installation on most European vehicles. The rotatable angular connection allows the use even when there is less space at the surge tank.

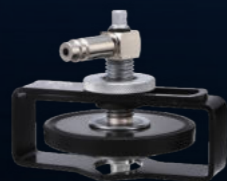

01491L 49,00 EUR*

BRAKE DISC GAUGE, 60 MM

Specifically for measuring brake disc thickness.

- ▶ Measuring range: 0 - 60 mm
- ▶ Vernier scale: 0.1 mm
- ▶ Length of outer measuring arms: 50 mm
- ▶ Inox, hardened



72345L 52,50 EUR*

BRAKE PEDAL RETAINING TOOL

is an ideal tool for the venting of hydraulic brake systems and for checking the braking force regulator.



01479L 104,06 EUR*

BRAKE FLUID TESTER

electronic, for determining the water content in the brake fluid. Its compact design means it fits nicely into the service technician's overall pocket, the state of the brake fluid is determined quickly and shown in five stages (green - yellow - red).

Delivery including 1 x 1.5V AAA battery.

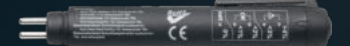

21555L 19,95 EUR*

COATING THICKNESS GAUGE, NON-FERROUS METALS

For universal use for determining paint thickness on iron and NF metals.

- ▶ Digital display with lighting
- ▶ Measuring frame "Stärke": 0 bis 40 mils (0 bis 1000 µm)
- ▶ Resolution: 0,1 mils/1 µm
- ▶ ...



72375L 216,90 EUR*

VEHICLE WINDOW ASSEMBLY FRAME, 100 KG

for the quick and simple assembly and disassembly of larger vehicle windows.

- ▶ With 4 mobile suction cups which have a warning line when there is a loss of vacuum pressure
- ▶ wWith 4 mobile feet for comfortably casting off the frame e.g. onto a SW-Stahl factory vehicle
- ▶ Suction cup diameter 150 mm
- ▶ Aluminum frame



40017L 299,90 EUR*

WIPER REMOVAL SET, 8-PIECE

Makes the absolute straightforward removal of all standard wiper arms possible. Best application possibilities with corroded and stuck wiper arms. Best possible protection for integrated wiper nozzles thanks to hammer technology.



10122L 179,90 EUR*

AIRBAG TOOL SET, 10-PIECE

for removing the airbag units as well as for installing and dismantling airbags on VAG, BMW etc.



04403L 62,90 EUR*

MOUNTING WEDGE SET, 11-PIECE

made of glass-fibre reinforced plastic. For interior linings, for the damage-free installation and removal of lining parts, plastic clips, rear view mirrors etc. even in spots that are difficult to reach.



94807L 29,90 EUR*

CLIP REMOVER SET, 5-PIECE

INOX - stainless steel with 2-component plastic handles.

- ▶ U-shape lever (inner 8.2 mm / outer 31.5 mm)
- ▶ V-shape lever 38 mm (inner 4-12.5 mm / outer 31.5 mm)
- ▶ U-shape lever (inner 6.15 mm / outer 12.8 mm)
- ▶ V-shape lever 13 mm (inner 1-4,4 mm / outer 12,8 mm)
- ▶ U-shape lever 38 mm, extra long curved (inner 8,4 mm / outer 31,4 mm)



94845L 28,90 EUR*

DOOR LINING LOOSENER SET, UNIVERSAL

angle 15 degrees, for fast, easy removal of interior linings.

- ▶ Universal use through 3 different sizes 4, 8 and 10 mm
- ▶ Two different lengths 235 mm and 495 mm
- ▶ Good handling through appropriately formed handle
- ▶ With suspension hole



94885L 29,90 EUR*

SHEAR RIVET TOOL, 500 MM

for aluminium and steel rivets and rivet nuts, with many accessories, an absolute must for working on riveted window lifters.

- ▶ Pads 3.2 - 4.0 - 4.8 - 5.0 - 6.4 mm
- ▶ Rivet nuts M4 - 5 - 6 - 8 - 10
- ▶ Handles can be unfolded to 500 mm
- ▶ Little force required



42760L 169,90 EUR*

HIGH VOLTAGE



SW STAHL
PROFESSIONAL TOOLS

FACE SHIELD, CLASS 1

HIGH VOLTAGE

- ▶ Approved for protection against electric arcs (according to GS-ET-29, status 2019-06, class 1).
- ▶ Colourless visor according to EN 170 made of high impact polycarbonate
- ▶ With width-adjustable headband
- ▶ Fog-free



11150L 109,90 EUR*

BATTERY TESTER WITH PRINTER, 12V / 24V

The tester checks systems at 12 and 24 volts, the battery's state of charge, the battery load when starting the engine, performs an extended load test and checks that the generator is charged. The following battery types can be checked:

- ▶ Lead-acid battery (wet cell)
- ▶ VRLA battery (Valve-Regulated Lead-Acid Battery)
- ▶ GEL/SLA battery (Sealed Lead Acid Battery)
- ▶ EFB battery (Enhanced Flooded Battery)
- ▶ AGM battery (Absorbent Glass Mat Battery)



32275L 289,90 EUR*

ELECTRICALLY INSULATING PROTECTIVE GLOVES

- ▶ Electrically insulating protective gloves for live working, 1 pair
- ▶ Protection class 0
- ▶ Insulation according to DIN EN 60903
- ▶ For voltage up to 1000 V AC and up to 1500 V DC



SIZE 9

SIZE 10

11570L 64,90 EUR*

11571L 64,90 EUR*

UNDER GLOVES, 1 PAIR

The under gloves are worn under the insulating glove to improve comfort.

- ▶ Made without seams: maximum wearing comfort
- ▶ Material: 100% cotton
- ▶ Elasticated cuff
- ▶ Universal size



11572L 7,10 EUR*

INSULATED TOOL SET, 50-PIECE

All components of the tool set are certified according to the standard DIN EN 60900 VDE 0682-201:2013-04 and thus insulated up to 1,000 V AC or 1,500 V DC.

Contents:

- ▶ Insulated screwdrivers: PH1, PH2, PH3, T20, T25, T30, 2.5 - 3 - 3.5 - 4 mm
- ▶ Insulated 10 mm (3/8") socket spanner bits: 6 - 7 - 8 - 10 - 11 - 12 - 13 - 14 - 15 - 16 - 17 - 18 - 19 - 20 - 21 - 22 mm
- ▶ Insulated 10 mm (3/8") screwdriver bits: M8, M10, M12
- ▶ Insulated 10 mm (3/8") extensions: 150 and 250 mm
- ▶ Stripping knife
- ▶ Insulated water pump pliers, 250 mm
- ▶ Insulated telephone pliers, straight, 200 mm
- ▶ Insulated telephone pliers, bent, 200 mm
- ▶ Insulated cable cutter, 200 mm
- ▶ Insulated combination pliers, 180 mm
- ▶ Insulated side cutter, 160 mm
- ▶ 10 insulating capes
- ▶ Insulated ratchet, 10 mm (3/8")

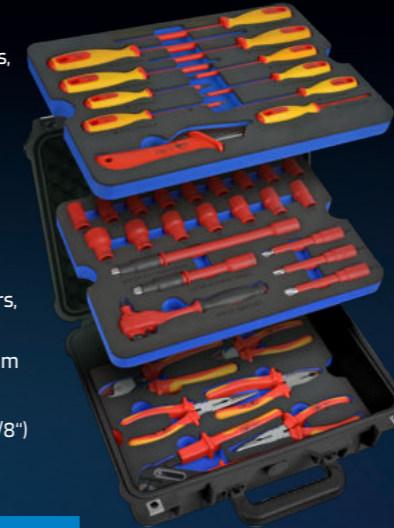

V1000 579,90 EUR*

HIGH-VOLTAGE TESTER

- ▶ For testing the absence of voltage on high-voltage vehicles
- ▶ Insulation according to CAT III 690 V, CAT IV 600 V
- ▶ DC/AC voltage measurement
- ▶ Single-pole voltage detection
- ▶ With LED illumination lamp
- ▶ Voltage range: 6 - 690 V AC/DC



32233L 59,90 EUR*

WORKPLACE BARRIER SET

consisting of:

- ▶ 4 pcs mobile plastic chain stands with 2 eyelets for hanging up barrier chains
- ▶ 4 pcs S-hook, 8 mm, red
- ▶ 1 pcs plastic connecting links, 8 mm, red
- ▶ Plastic barrier chain, 25 metres



07326L 199,90 EUR*

ADHESIVE LABEL FOR DAMAGED E-VEHICLES

- ▶ Is stuck on the windows of the damaged vehicle.
- ▶ The label is easily removable after towing and repair.
- ▶ Dimensions 100 x 200 mm



07330L 17,38 EUR*

JUMPER CABLE, 3,5 M

- ▶ With sturdy insulated clamps
- ▶ 12 mm diameter / 25 mm²



S9612 34,90 EUR*

PLASTIC BARRIER CHAIN, 25 METRES



07321L 69,90 EUR*

S-HOOK, 8 MM, RED



07324L 2,15 EUR*

SOLDER FIXING PLIERS

for support during cable soldering. The cable ends to be soldered are stripped, clamped to the pliers jaws and aligned to one another. The pliers can be tightened, allowing them to be set down and leaving both hands free for soldering.



42415L 19,90 EUR*

E-MOBILITY STARTER SET S, 27-PIECE

With the E-Mobility Starter Set S, you meet the requirements of the DGUV with regard to work on vehicles with high-voltage systems.

Contents:

- Personal protective equipment
- Safety barriers
- Information and prohibition signs
- Voltage tester



V1100 779,90 EUR*

PLASTIC CONNECTING LINK, 8 MM, RED

- For connecting barrier chains
- Colour: red
- Diameter: 8 mm



07322L 2,15 EUR*

BARRIER WARNING TAPE, 100 METRES

- Robust design, printed diagonally on both sides
- Colour: red/white
- Length: 100 metres
- Width: 80 mm
- Thickness: approx. 30 µ



07325L 11,50 EUR*

E-MOBILITY STARTER SET L, 77-PIECE

With the E-Mobility Starter Set L, you meet the requirements of the DGUV relating to work on vehicles with high-voltage systems.

Contents:

- Personal protective equipment
- Safety barriers
- Information and prohibition signs
- Voltage tester
- Insulated hand tools



V1200 1299,90 EUR*

PROHIBITION SIGN "SWITCHING PROHIBITED"

- According to DGUV-Information 200-005
- Magnetic prohibition sign to be attached to the outside of the vehicle
- To prevent unintentional switching on of the current
- Self-inscribable field for the name of the HV specialist and his telephone number
- With pictogram „Switching prohibited“ according to ASR A1.3, DIN EN ISO 7010/P031
- Magnetic foil, 297 x 210 mm



07335L 55,90 EUR*

INFORMATION SIGN "HIGH-VOLTAGE SWITCHED ON"

- According to DGUV-Information 200-005
- Magnetic prohibition sign to be attached to the outside of the vehicle
- To prevent accidents on high-voltage vehicles
- Self-inscribable field for the name of the HV specialist and his telephone number
- Warning sign „Warning of dangerous electrical voltage“ in accordance with DIN4844D-W008.
- Magnetic foil, 297 x 210 mm



07336L 55,90 EUR*

INFORMATION SIGN "FIRST AID"

- First aid notice for accidents caused by electric current
- With additional warning notice „Warning of electrical voltage“ in accordance with current ISO 7010 and modernised pictograms
- Tried and tested in practice
- For indoor and outdoor use
- Material: plastic, 595 x 410 mm



07337L 55,90 EUR*

INFORMATION SIGN "SAFETY RULES"

- Based on DGUV Information 200-005
- Safety rules to avoid electrical accidents when working on vehicles with high-voltage systems
- Mounting holes: Diameter 5 mm
- Plastic information sign, 350 x 500 mm



07338L 55,90 EUR*

TETRAHEDRAL WARNING SIGN "LIGHTNING ARROW"

- ▶ Tetrahedral roof sign made of plastic with suction base
- ▶ Three-sided warning sign „Lightning arrow“
- ▶ Warning of dangerous electrical voltage according to DIN EN ISO 7010
- ▶ For marking during repair/maintenance work on electric vehicles



07331L 35,10 EUR*

INFORMATION SIGN FOR ELECTRIC AND HYBRID VEHICLES

- ▶ Information sign to prevent electrical accidents when working on electric and hybrid vehicles
- ▶ With pictogram "Warning of electrical voltage" according to ASR A1.3, DIN EN ISO 7010/W012
- ▶ With pictogram "Touching prohibited" according to ASR A1.3, DIN EN ISO 7010/P010
- ▶ With pictogram "Access for unauthorised persons prohibited" in accordance with DIN EN ISO 4844-2/D-P006
- ▶ Made of plastic, 440 x 140 mm



07332L 35,10 EUR*

MAINTENANCE TAG "SWITCHING PROHIBITED"

- ▶ According to DGUV-Information 200-005
- ▶ Warning tag for mounting in the vehicle
- ▶ To prevent unintentional switching on of the current
- ▶ Combination plate for attaching to the Service-Disconnect
- ▶ Self-labelling field for the name of the HV specialist and his telephone number
- ▶ With pictogram "Switching prohibited" according to ASR A1.3, DIN EN ISO 7010/P031
- ▶ Made of plastic, 75 x 150 mm

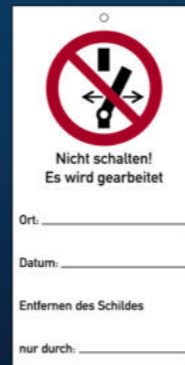

07333L 5,70 EUR*

PROHIBITION SIGN "CHARGING PROHIBITED"

- ▶ Magnetic prohibition sign to be attached to the outside of the vehicle
- ▶ To prevent unintentional charging of the vehicle battery
- ▶ Magnetic foil, 297 x 210 mm



07334L 55,90 EUR*

INDUSTRY BENCH VISE, 125 MM JAW WIDTH

- ▶ Vise opening to the front
- ▶ With anvil plate and interchangeable jaws
- ▶ Including spindle with trapezoidal thread
- ▶ Including pipe tensioning devices
- ▶ High tightening torques possible
- ▶ Knurled clamping jaw surface for better adhesion

Technical specifications:

- ▶ Mounting plate with diameter 150 mm
- ▶ Mounting holes with diameter 14 mm
- ▶ Jaw width 125 mm
- ▶ Span 140 mm

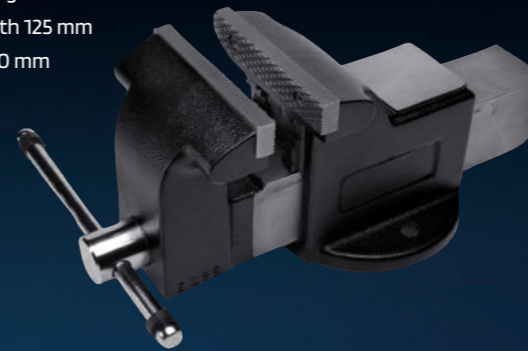

50825L 119,90 EUR*

INSPECTION LAMP, 500 LUMEN

The ergonomically designed LED inspection lamp with SMD technology is your reliable companion throughout the day. The use of high-quality materials, such as aluminium and polycarbonate, makes the lamp virtually indestructible and ensures user safety during operation. The lamp can be mounted quickly and securely using the practical clip hook and a strong neodymium magnet.

- Features:**
- ▶ Shatterproof from up to 3 metres height
 - ▶ USB charging cable with AC/DC adapter
 - ▶ Clip hook with neodymium magnet



S9791 34,90 EUR*

ENGINE COMPARTMENT LIGHT

- ▶ Extremely bright illumination of the entire engine compartment due to the high-performance 40W SMD LED technology
- ▶ 2-Stage adjustable lighting
- ▶ Telescopic support extendible from approx. 112 to 188 cm
- ▶ Space-efficient storage (Light 89,5 x 2,7 cm; telescopic support 112 x 10 x 6 cm)
- ▶ Very low weight (1.000 g incl. telescopic support)
- ▶ Luminous flux 800 Lm (Stage 1) and 1.500 Lm (Stage 2)



S9745 99,90 EUR*

HANDHELD LAMP, 1,000 LUMEN

The portable hand lamp with COB technology is virtually indestructible thanks to the use of a metal housing with a polycarbonate cover. It is splash-proof and shines particularly brightly with 1,000 lumens. The integrated Li-Ion rechargeable battery provides enough power for a long working day and is durable and environmentally friendly thanks to the latest technology.

- ▶ With emergency light operation for several hours
- ▶ Shatterproof from a height of up to 2 metres
- ▶ Splash-proof, IP54
- ▶ Charging station with wall mounting option
- ▶ USB charging cable with AC/DC adapter
- ▶ 2 neodymium magnets on fold-out light support.



S9790 49,90 EUR*

LED ELECTRIC TORCH

with aluminium housing, reflector and lens focussed beam. On/off switch on rear.



S9811 9,90 EUR*

LED BATTERY HEAD LAMP, 2W COB

- ▶ Powerful, flicker-free light with 2W COB LED
- ▶ Low heat generation and uniform light distribution
- ▶ Dimensions approx. 100 x 50 x 40 mm
- ▶ 2-level adjustable lighting
- ▶ Excellent fit with adjustable rubber band
- ▶ Can be used under cap, helmet or other head gear
- ▶ Luminous flux 100 Lm (level 1) or 180 Lm (level 2)
- ▶ Integrated 3.7V / 1800 mAh Li-Ion battery
- ▶ Incl. USB-charging cable with adapter for socket



S9716 14,90 EUR*

THE DOUBLE AWARD-WINNING TOOL TROLLEY



DESIGNED
IN GERMANY

red dot winner 2023

PROFESSIONAL TOOL TROLLEY TT801, BLACK, UNEQUIPPED

Modern tool trolley for professional use in all automotive and industrial businesses. The TWIN-Lock locking system makes it possible to choose whether only one or all drawers can be opened at the same time.

- ▶ 8 drawers with heavy-duty slides
- ▶ Quick-locking mechanism with soft close function on each drawer
- ▶ Stainless steel top cover with embossed grooves and side sealing
- ▶ Wheels with TPE treads ensure smooth running
- ▶ TWIN-Lock locking system
- ▶ Centrally lockable
- ▶ Magnetic storage shelves
- ▶ Edge protectors
- ▶ Paper roll holder and can holder included
- ▶ Further accessories available



07101L 1099,90 EUR*

PROFESSIONAL TOOL TROLLEY TT801, BLUE, UNEQUIPPED

Modern tool trolley for professional use in all automotive and industrial businesses. The TWIN-Lock locking system makes it possible to choose whether only one or all drawers can be opened at the same time.

- ▶ 8 drawers with heavy-duty slides
- ▶ Quick-locking mechanism with soft close function on each drawer
- ▶ Stainless steel top cover with embossed grooves and side sealing
- ▶ Wheels with TPE treads ensure smooth running
- ▶ TWIN-Lock locking system
- ▶ Centrally lockable
- ▶ Magnetic storage shelves
- ▶ Edge protectors
- ▶ Paper roll holder and can holder included
- ▶ Further accessories available



07100L 999,90 EUR*

PROFESSIONAL TOOL TROLLEY TT802, BLACK, UNEQUIPPED

Extra wide and modern tool trolley for professional use in all automotive and industrial businesses. The TWIN-Lock locking system makes it possible to choose whether only one or all drawers can be opened at the same time.

- ▶ 8 drawers with heavy-duty slides
- ▶ Quick-locking mechanism with soft close function on each drawer
- ▶ Stainless steel top cover with embossed grooves and side sealing
- ▶ Wheels with TPE treads ensure smooth running
- ▶ TWIN-Lock locking system
- ▶ Centrally lockable
- ▶ Magnetic storage shelves
- ▶ Edge protectors
- ▶ Paper roll holder and can holder included
- ▶ Further accessories available



07111L 1349,90 EUR*

PROFESSIONAL TOOL TROLLEY TT802, BLUE, UNEQUIPPED

Extra wide and modern tool trolley for professional use in all automotive and industrial businesses. The TWIN-Lock locking system makes it possible to choose whether only one or all drawers can be opened at the same time.

- ▶ 8 drawers with heavy-duty slides
- ▶ Quick-locking mechanism with soft close function on each drawer
- ▶ Stainless steel top cover with embossed grooves and side sealing
- ▶ Wheels with TPE treads ensure smooth running
- ▶ TWIN-Lock locking system
- ▶ Centrally lockable
- ▶ Magnetic storage shelves
- ▶ Edge protectors
- ▶ Paper roll holder and can holder included
- ▶ Further accessories available



07110L 1299,90 EUR*

**PROFESSIONAL TOOL TROLLEY TT801,
BLACK, EQUIPPED, 213-PIECE, 3 INLAYS**

Modern tool trolley for professional use in all automotive and industrial businesses. The TWIN-Lock locking system makes it possible to choose whether only one or all drawers can be opened at the same time. 3 Drawers equipped with 213 Tools in premium quality, stored in 3/3 system foam inserts.

- ▶ 8 drawers with heavy-duty slides
- ▶ Quick-locking mechanism with soft close function on each drawer
- ▶ Stainless steel top cover with embossed grooves and side sealing
- ▶ Wheels with TPE treads ensure smooth running
- ▶ TWIN-Lock locking system
- ▶ For further details on the tool trolley, see article 07101L

Contains the following equipped 3/3 system foam inserts:

- ▶ Z3011-6 / Tool assortment, Screwdrivers and pliers, 25-piece
- ▶ Z3011-14 / Tool assortment, 1/4", 3/8", 1/2", with ratchets, 144-piece
- ▶ Z3011-15 / Tool assortment, Combination spanners and general hand tools, 44-piece



TT801
BLACK

reddot winner 2023

Z3117

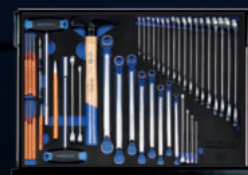

Z3117 1839,90 EUR*

**PROFESSIONAL TOOL TROLLEY TT801,
BLUE, EQUIPPED, 213-PIECE, 3 INLAYS**

Modern tool trolley for professional use in all automotive and industrial businesses. The TWIN-Lock locking system makes it possible to choose whether only one or all drawers can be opened at the same time. 3 Drawers equipped with 213 Tools in premium quality, stored in 3/3 system foam inserts.

- ▶ 8 drawers with heavy-duty slides
- ▶ Quick-locking mechanism with soft close function on each drawer
- ▶ Stainless steel top cover with embossed grooves and side sealing
- ▶ Wheels with TPE treads ensure smooth running
- ▶ TWIN-Lock locking system
- ▶ For further details on the tool trolley, see article 07100L

Contains the following equipped 3/3 system foam inserts:

- ▶ Z3011-6 / Tool assortment, Screwdrivers and pliers, 25-piece
- ▶ Z3011-14 / Tool assortment, 1/4", 3/8", 1/2", with ratchets, 144-piece
- ▶ Z3011-15 / Tool assortment, Combination spanners and general hand tools, 44-piece



TT801
BLUE

reddot winner 2023

Z3116

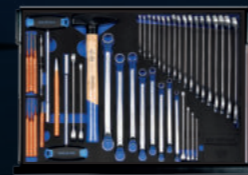

Z3116 1739,90 EUR*

**PROFESSIONAL TOOL TROLLEY TT802,
BLACK, EQUIPPED, 304-PIECE, 3 INLAYS**

Extra wide and modern tool trolley for professional use in all automotive and industrial businesses. The TWIN-Lock locking system makes it possible to choose whether only one or all drawers can be opened at the same time. 3 Drawers equipped with 304 Tools in premium quality, stored in 4/3 system foam inserts.

- ▶ 8 drawers with heavy-duty slides
- ▶ Quick-locking mechanism with soft close function on each drawer
- ▶ Stainless steel top cover with embossed grooves and side sealing
- ▶ Wheels with TPE treads ensure smooth running
- ▶ TWIN-Lock locking system
- ▶ For further details on the tool trolley, see article 07111L

Contains the following equipped 4/3 system foam inserts:

- ▶ Z3011-3 / Tool assortment, 1/4", 3/8", 1/2", with ratchets, 203-piece
- ▶ Z3011-5 / Tool assortment, Combination and ratchet spanners, 57-piece
- ▶ Z3011-8 / Tool assortment, Screwdrivers and pliers, 44-piece

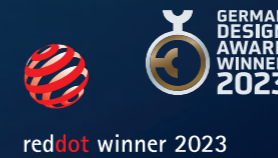

TT802
BLACK

reddot winner 2023

Z3209

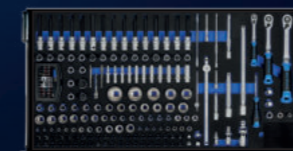

Z3209 2309,90 EUR*

**PROFESSIONAL TOOL TROLLEY TT802,
BLUE, EQUIPPED, 304-PIECE, 3 INLAYS**

Extra wide and modern tool trolley for professional use in all automotive and industrial businesses. The TWIN-Lock locking system makes it possible to choose whether only one or all drawers can be opened at the same time. 3 Drawers equipped with 304 Tools in premium quality, stored in 4/3 system foam inserts.

- ▶ 8 drawers with heavy-duty slides
- ▶ Quick-locking mechanism with soft close function on each drawer
- ▶ Stainless steel top cover with embossed grooves and side sealing
- ▶ Wheels with TPE treads ensure smooth running
- ▶ TWIN-Lock locking system
- ▶ For further details on the tool trolley, see article 07110L

Contains the following equipped 4/3 system foam inserts:

- ▶ Z3011-3 / Tool assortment, 1/4", 3/8", 1/2", with ratchets, 203-piece
- ▶ Z3011-5 / Tool assortment, Combination and ratchet spanners, 57-piece
- ▶ Z3011-8 / Tool assortment, Screwdrivers and pliers, 44-piece



TT802
BLUE

reddot winner 2023

Z3208

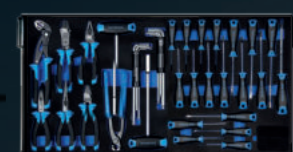
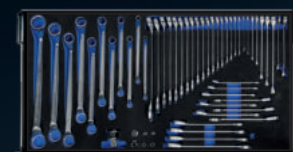
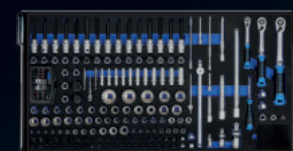

Z3208 2209,90 EUR*

**PROFESSIONAL TOOL TROLLEY TT802,
BLACK, EQUIPPED, 338-PIECE, 4 INLAYS**

Extra wide and modern tool trolley for professional use in all automotive and industrial businesses. The TWIN-Lock locking system makes it possible to choose whether only one or all drawers can be opened at the same time. 4 Drawers equipped with 338 Tools in premium quality, stored in 4/3 system foam inserts.

- ▶ 8 drawers with heavy-duty slides
- ▶ Quick-locking mechanism with soft close function on each drawer
- ▶ Stainless steel top cover with embossed grooves and side sealing
- ▶ Wheels with TPE treads ensure smooth running
- ▶ TWIN-Lock locking system
- ▶ For further details on the tool trolley, see article 07111L

Contains the following equipped 4/3 system foam inserts:

- ▶ Z3011-3 / Tool assortment, 1/4", 3/8", 1/2", with ratchets, 203-piece
- ▶ Z3011-5 / Tool assortment, Combination and ratchet spanners, 57-piece
- ▶ Z3011-8 / Tool assortment, Screwdrivers and pliers, 44-piece
- ▶ Z3011-10 / Tool assortment, general hand tools, 34-piece

**PROFESSIONAL TOOL TROLLEY TT802,
BLUE, EQUIPPED, 338-PIECE, 4 INLAYS**

Extra wide and modern tool trolley for professional use in all automotive and industrial businesses. The TWIN-Lock locking system makes it possible to choose whether only one or all drawers can be opened at the same time. 4 Drawers equipped with 338 Tools in premium quality, stored in 4/3 system foam inserts.

- ▶ 8 drawers with heavy-duty slides
- ▶ Quick-locking mechanism with soft close function on each drawer
- ▶ Stainless steel top cover with embossed grooves and side sealing
- ▶ Wheels with TPE treads ensure smooth running
- ▶ TWIN-Lock locking system
- ▶ For further details on the tool trolley, see article 07110L

Contains the following equipped 4/3 system foam inserts:

- ▶ Z3011-3 / Tool assortment, 1/4", 3/8", 1/2", with ratchets, 203-piece
- ▶ Z3011-5 / Tool assortment, Combination and ratchet spanners, 57-piece
- ▶ Z3011-8 / Tool assortment, Screwdrivers and pliers, 44-piece
- ▶ Z3011-10 / Tool assortment, general hand tools, 34-piece

**PROFESSIONAL TOOL TROLLEY TT801,
BLACK, EQUIPPED, 246-PIECE, 4 INLAYS**

Modern tool trolley for professional use in all automotive and industrial businesses. The TWIN-Lock locking system makes it possible to choose whether only one or all drawers can be opened at the same time. 4 Drawers equipped with 246 Tools in premium quality, stored in 3/3 system foam inserts.

- ▶ 8 drawers with heavy-duty slides
- ▶ Quick-locking mechanism with soft close function on each drawer
- ▶ Stainless steel top cover with embossed grooves and side sealing
- ▶ Wheels with TPE treads ensure smooth running
- ▶ TWIN-Lock locking system
- ▶ For further details on the tool trolley, see article 07101L

Contains the following equipped 3/3 system foam inserts:

- ▶ Z3011-4 / Tool assortment, Combination and ratchet spanners, 49-piece
- ▶ Z3011-6 / Tool assortment, Screwdrivers and pliers, 25-piece
- ▶ Z3011-9 / Tool assortment, general hand tools, 28-piece
- ▶ Z3011-14 / Tool assortment, 1/4", 3/8", 1/2", with ratchets, 144-piece

**PROFESSIONAL TOOL TROLLEY TT801,
BLUE, EQUIPPED, 246-PIECE, 4 INLAYS**

Modern tool trolley for professional use in all automotive and industrial businesses. The TWIN-Lock locking system makes it possible to choose whether only one or all drawers can be opened at the same time. 4 Drawers equipped with 246 Tools in premium quality, stored in 3/3 system foam inserts.

- ▶ 8 drawers with heavy-duty slides
- ▶ Quick-locking mechanism with soft close function on each drawer
- ▶ Stainless steel top cover with embossed grooves and side sealing
- ▶ Wheels with TPE treads ensure smooth running
- ▶ TWIN-Lock locking system
- ▶ For further details on the tool trolley, see article 07100L

Contains the following equipped 3/3 system foam inserts:

- ▶ Z3011-4 / Tool assortment, Combination and ratchet spanners, 49-piece
- ▶ Z3011-6 / Tool assortment, Screwdrivers and pliers, 25-piece
- ▶ Z3011-9 / Tool assortment, general hand tools, 28-piece
- ▶ Z3011-14 / Tool assortment, 1/4", 3/8", 1/2", with ratchets, 144-piece

TT802
BLACK
Z3212

SW STAHL
PROFESSIONAL TOOLS

GERMAN DESIGN AWARD WINNER 2023

reddot winner 2023

Z3212 2619,90 EUR*

TT802
BLUE
Z3211

SW STAHL
PROFESSIONAL TOOLS

GERMAN DESIGN AWARD WINNER 2023

reddot winner 2023

Z3211 2519,90 EUR*

TT801
BLACK
Z3114

SW STAHL
PROFESSIONAL TOOLS

GERMAN DESIGN AWARD WINNER 2023

reddot winner 2023

Z3114 2049,90 EUR*

TT801
BLUE
Z3113

SW STAHL
PROFESSIONAL TOOLS

GERMAN DESIGN AWARD WINNER 2023

reddot winner 2023

Z3113 1949,90 EUR*

**PROFESSIONAL TOOL TROLLEY TT802,
BLACK, EQUIPPED, 434-PIECE, 5 INLAYS**

Extra wide and modern tool trolley for professional use in all automotive and industrial businesses. The TWIN-Lock locking system makes it possible to choose whether only one or all drawers can be opened at the same time. 5 Drawers equipped with 434 Tools in premium quality, stored in 4/3 system foam inserts.

- ▶ 8 drawers with heavy-duty slides
- ▶ Quick-locking mechanism with soft close function on each drawer
- ▶ Stainless steel top cover with embossed grooves and side sealing
- ▶ Wheels with TPE treads ensure smooth running
- ▶ TWIN-Lock locking system
- ▶ For further details on the tool trolley, see article 07111L

Contains the following equipped 4/3 system foam inserts:

- ▶ Z3011-5 / Tool assortment, Combination and ratchet spanners, 57-piece
- ▶ Z3011-8 / Tool assortment, Screwdrivers and pliers, 44-piece
- ▶ Z3011-10 / Tool assortment, general hand tools, 34-piece
- ▶ Z3011-12 / Tool assortment, 1/2", with ratchet, 95-piece
- ▶ Z3011-13 / Tool assortment, 1/4", 3/8", with ratchets, 204-piece

**PROFESSIONAL TOOL TROLLEY TT802,
BLUE, EQUIPPED, 434-PIECE, 5 INLAYS**

Extra wide and modern tool trolley for professional use in all automotive and industrial businesses. The TWIN-Lock locking system makes it possible to choose whether only one or all drawers can be opened at the same time. 5 Drawers equipped with 434 Tools in premium quality, stored in 4/3 system foam inserts.

- ▶ 8 drawers with heavy-duty slides
- ▶ Quick-locking mechanism with soft close function on each drawer
- ▶ Stainless steel top cover with embossed grooves and side sealing
- ▶ Wheels with TPE treads ensure smooth running
- ▶ TWIN-Lock locking system
- ▶ For further details on the tool trolley, see article 07110L

Contains the following equipped 4/3 system foam inserts:

- ▶ Z3011-5 / Tool assortment, Combination and ratchet spanners, 57-piece
- ▶ Z3011-8 / Tool assortment, Screwdrivers and pliers, 44-piece
- ▶ Z3011-10 / Tool assortment, general hand tools, 34-piece
- ▶ Z3011-12 / Tool assortment, 1/2", with ratchet, 95-piece
- ▶ Z3011-13 / Tool assortment, 1/4", 3/8", with ratchets, 204-piece

**PROFESSIONAL TOOL TROLLEY TT801,
BLACK, EQUIPPED, 341-PIECE, 5 INLAYS**

Modern tool trolley for professional use in all automotive and industrial businesses. The TWIN-Lock locking system makes it possible to choose whether only one or all drawers can be opened at the same time. 5 Drawers equipped with 341 Tools in premium quality, stored in 3/3 system foam inserts.

- ▶ 8 drawers with heavy-duty slides
- ▶ Quick-locking mechanism with soft close function on each drawer
- ▶ Stainless steel top cover with embossed grooves and side sealing
- ▶ Wheels with TPE treads ensure smooth running
- ▶ TWIN-Lock locking system
- ▶ For further details on the tool trolley, see article 07101L

Contains the following equipped 3/3 system foam inserts:

- ▶ Z3011-1 / Tool assortment, 1/4", 3/8", 1/2", with ratchets, 167-piece
- ▶ Z3011-4 / Tool assortment, Combination and ratchet spanners, 49-piece
- ▶ Z3011-6 / Tool assortment, Screwdrivers and pliers, 25-piece
- ▶ Z3011-9 / Tool assortment, general hand tools, 28-piece
- ▶ Z3011-11 / Tool assortment, Bit-sockets 1/2", 72-piece

**PROFESSIONAL TOOL TROLLEY TT801,
BLUE, EQUIPPED, 341-PIECE, 5 INLAYS**

Modern tool trolley for professional use in all automotive and industrial businesses. The TWIN-Lock locking system makes it possible to choose whether only one or all drawers can be opened at the same time. 5 Drawers equipped with 341 Tools in premium quality, stored in 3/3 system foam inserts.

- ▶ 8 drawers with heavy-duty slides
- ▶ Quick-locking mechanism with soft close function on each drawer
- ▶ Stainless steel top cover with embossed grooves and side sealing
- ▶ Wheels with TPE treads ensure smooth running
- ▶ TWIN-Lock locking system
- ▶ For further details on the tool trolley, see article 07100L

Contains the following equipped 3/3 system foam inserts:

- ▶ Z3011-1 / Tool assortment, 1/4", 3/8", 1/2", with ratchets, 167-piece
- ▶ Z3011-4 / Tool assortment, Combination and ratchet spanners, 49-piece
- ▶ Z3011-6 / Tool assortment, Screwdrivers and pliers, 25-piece
- ▶ Z3011-9 / Tool assortment, general hand tools, 28-piece
- ▶ Z3011-11 / Tool assortment, Bit-sockets 1/2", 72-piece

red dot winner 2023
 GERMAN DESIGN AWARD WINNER 2023
TT802
 BLACK
Z3201
 SW STAHL
 PROFESSIONAL TOOLS
 Z3201 3249,90 EUR*

red dot winner 2023
 GERMAN DESIGN AWARD WINNER 2023
TT802
 BLUE
Z3200
 SW STAHL
 PROFESSIONAL TOOLS
 Z3200 3149,90 EUR*

red dot winner 2023
 GERMAN DESIGN AWARD WINNER 2023
TT801
 BLACK
Z3111
 SW STAHL
 PROFESSIONAL TOOLS
 Z3111 2619,90 EUR*

red dot winner 2023
 GERMAN DESIGN AWARD WINNER 2023
TT801
 BLUE
Z3110
 SW STAHL
 PROFESSIONAL TOOLS
 Z3110 2519,90 EUR*

WORKSHOP MOBILE TOOL CHEST, EQUIPPED, 207-PIECE

Tool chest with 7 drawers

„Worker-Set“ - 3 drawers equipped with a total of 207 tools in premium-quality, stored in foam modules.



Z3703 699,90 EUR*

WORKSHOP MOBILE TOOL CHEST, EQUIPPED, 347-PIECE

Tool chest with 7 drawers

„Worker-Set“ - 5 drawers equipped with a total of 347 tools in premium-quality, stored in foam modules.



Z3705 1049,90 EUR*

TOOL ASSORTMENT, SOCKETS 1/4", 3/8", 1/2", WITH RATCHETS, 203-PIECE

- ▶ Socket set, extensions and ratchets in 1/4", 3/8" and 1/2"
- ▶ Equipped with 203 tools
- ▶ SW-Stahl system foam insert, size 4/3
- ▶ For drawers with 760 x 400 mm

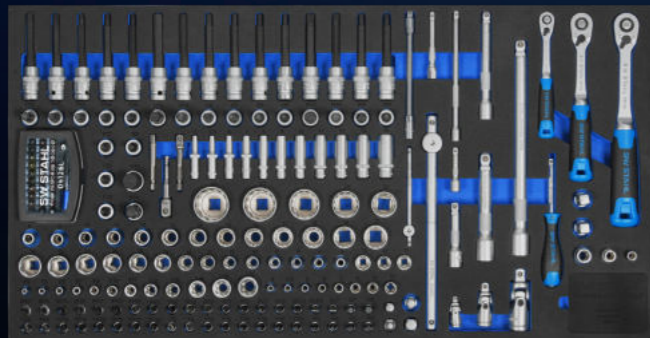

Z3011-3 533,90 EUR*

TOOL ASSORTMENT, COMBINATION AND RATCHET SPANNERS, 57-PIECE

- ▶ Combination spanners, double-ring spanners, cranked
- ▶ Combination ratchet spanners
- ▶ Double-ring spanners, Adapter set for sockets and bits
- ▶ Equipped with 57 tools
- ▶ SW-Stahl system foam insert, size 4/3
- ▶ For drawers with 760 x 400 mm



Z3011-5 390,90 EUR*

TOOL ASSORTMENT, SOCKETS 1/4", 3/8", WITH RATCHETS, 204-PIECE

- ▶ Socket set, extensions and ratchets in 1/4" and 3/8"
- ▶ Equipped with 204 tools
- ▶ SW-Stahl system foam insert, size 4/3
- ▶ For drawers with 760 x 400 mm

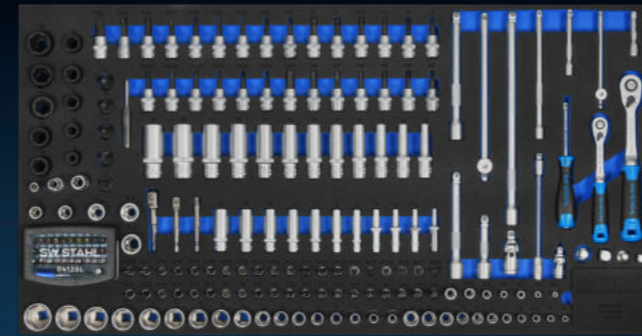

Z3011-13 569,90 EUR*

TOOL ASSORTMENT, SOCKETS 1/2", WITH RATCHET, 95-PIECE

- ▶ Socket set, extensions and high torque ratchet in 1/2"
- ▶ Equipped with 95 tools
- ▶ SW-Stahl system foam insert, size 4/3
- ▶ For drawers with 760 x 400 mm



Z3011-12 569,90 EUR*

TOOL ASSORTMENT, GENERAL HAND TOOLS, 34-PIECE

- ▶ Hammer, flat chisel, centre punch, pin punch
- ▶ Feeler gauge, flexible screwdriver, files
- ▶ Magnetic lifter, brake caliper brush, spark plug sockets
- ▶ Wheel nut sockets, knife, caliper gauge, tape measure
- ▶ Equipped with 34 tools
- ▶ SW-Stahl system foam insert, size 4/3
- ▶ For drawers with 760 x 400 mm



Z3011-10 408,90 EUR*

TOOL ASSORTMENT, SCREWDRIVERS AND PLIERS, 44-PIECE

- ▶ 6 pliers, 19 screwdrivers
- ▶ Allen keys with hexagon socket and T-profile
- ▶ T-handle socket spanners, hexagonal, 8 and 10 mm
- ▶ Equipped with 44 tools
- ▶ SW-Stahl system foam insert, size 4/3
- ▶ For drawers with 760 x 400 mm



Z3011-8 304,90 EUR*

MOULDED INSERT IMPACT SOCKET SET, 21-PIECE

for maxi workshop mobile tool chest. In solid petrol- and solvent-resistant fitting. Socket set 20 mm (3/4"), impact:

- ▶ Reversible ratchet with screwed shaft 500 mm
- ▶ 6, inserts 19, 21, 22, 23, 24, 26, 27, 29, 30, 32, 35, 36, 38, 41, 46,
- ▶ Universal joint
- ▶ Extensions 100 mm and 250 mm
- ▶ Sliding handle 450 mm



Z3000-18 393,60 EUR*

MOULDED INSERT, CIRCLIP PLIER SET, 5-PIECE

for maxi workshop mobile tool chest. In petrol- and solvent-resistant fit insert. Set of circlip pliers:

- ▶ Circlip pliers, straight, outside
- ▶ Circlip pliers, curved, outside
- ▶ Circlip pliers, straight, inside
- ▶ Circlip pliers, curved, inside
- ▶ Circlip pliers, wheel bearings

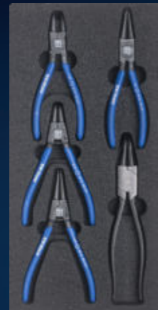

Z3013-33 89,50 EUR*

TOOL ASSORTMENT, SOCKETS 1/4", 3/8", 1/2", WITH RATCHETS, 167-PIECE

- ▶ Socket set, extensions and ratchets in 1/4", 3/8" and 1/2"
- ▶ Equipped with 167 tools
- ▶ SW-Stahl system foam insert, size 3/3
- ▶ For drawers with 570 x 400 mm



Z3011-1 479,90 EUR*

MOULDED INSERT, MALLET AND PUNCH SET, 5-PIECE

for maxi workshop mobile tool chest. In petrol- and solvent-resistant fit insert.

- ▶ Mallet, 1,000 g
- ▶ Pin drivers 10, 12, 14, 16 mm



Z3013-35 81,00 EUR*

TOOL ASSORTMENT, SOCKETS 1/4", 3/8", 1/2", WITH RATCHETS, 144-PIECE

- ▶ Socket set, extensions and ratchets in 1/4", 3/8" and 1/2"
- ▶ Equipped with 144 tools
- ▶ SW-Stahl system foam insert, size 3/3
- ▶ For drawers with 570 x 400 mm

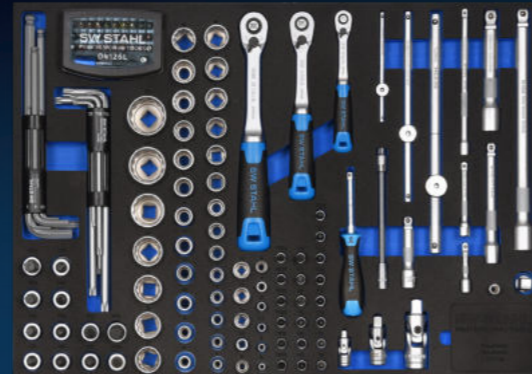

Z3011-14 390,90 EUR*

TOOL ASSORTMENT, BIT-SOCKETS 1/2", 72-PIECE

- ▶ Bit-sockets 1/2"
- ▶ Allen key sets and T-handle socket spanner
- ▶ Equipped with 72 tools
- ▶ SW-Stahl system foam insert, size 3/3
- ▶ For drawers with 570 x 400 mm

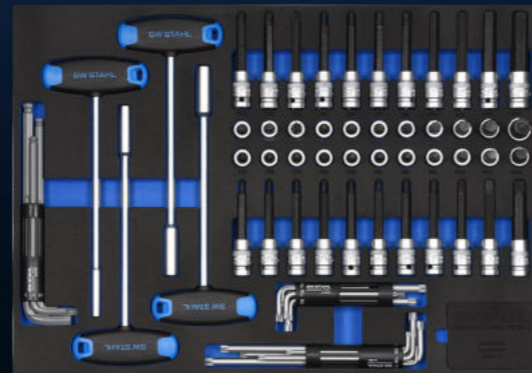

Z3011-11 417,90 EUR*

TOOL ASSORTMENT, COMBINATION SPANNERS AND GENERAL HAND TOOLS, 44-PIECE

- ▶ Combination spanners, double-ring spanners, T-handle socket spanners
- ▶ Hammer, flat chisel, centre punch
- ▶ Pin punches, telescopic magnetic lifter
- ▶ Equipped with 44 tools
- ▶ SW-Stahl system foam insert, size 3/3
- ▶ For drawers with 570 x 400 mm



Z3011-15 199,90 EUR*

TOOL ASSORTMENT, SCREWDRIVERS AND PLIERS, 25-PIECE

- ▶ Pliers and screwdrivers
- ▶ Equipped with 25 tools
- ▶ SW-Stahl system foam insert, size 3/3
- ▶ For drawers with 570 x 400 mm



Z3011-6 249,90 EUR*

TOOL ASSORTMENT, COMBINATION AND RATCHET SPANNERS, 49-PIECE

- ▶ 19 combination spanners, 6 mm - 27 mm
- ▶ 8 double-ring spanners, cranked, 6 mm - 22 mm
- ▶ 12 combination ratchet spanners, 8 mm - 19 mm
- ▶ 10 combination spanners, short, 10 mm - 19 mm
- ▶ Equipped with 49 tools
- ▶ SW-Stahl system foam insert, size 3/3
- ▶ For drawers with 570 x 400 mm



Z3011-4 320,90 EUR*

TOOL ASSORTMENT, GENERAL HAND TOOLS, 28-PIECE

- ▶ Hammer, flat chisel, centre punch, pin punch
- ▶ Feeler gauge, flexible screwdriver, files
- ▶ Magnetic lifter, brake caliper brush, spark plug sockets
- ▶ Wheel nut sockets, knife, caliper gauge, tape measure
- ▶ Equipped with 28 tools
- ▶ SW-Stahl system foam insert, size 3/3
- ▶ For drawers with 570 x 400 mm



Z3011-9 269,90 EUR*

CUSTOMISED DESIGN WITH THE RIGHT ACCESSORIES



T801

T802



DESIGNED
IN GERMANY



red dot winner 2023

CAN HOLDER

- ▶ Up to 3 cans
- ▶ Flexible and easy mounting
- ▶ For mounting in the perforated side wall



07120L 16,50 EUR*

PAPER ROLL HOLDER

- ▶ For paper rolls with maximum 300 mm diameter and 300 mm width
- ▶ Flexible and easy mounting
- ▶ For mounting in the perforated side wall



07121L 13,50 EUR*

DUST BIN

- ▶ Flexible and easy mounting
- ▶ For mounting in the perforated side wall



07122L 25,90 EUR*

SET DRAWER DIVIDER, 11-PIECE

To be used in case no foam inserts are used. For 60 mm drawer height.

Content:

- ▶ 3 pieces lengthwise rails
- ▶ 4 pieces Cross dividers, short
- ▶ 4 pieces Cross dividers, long



07123L 19,30 EUR*

LAPTOP HOLDER

For all common laptops and tablets. Including screen holder.

- ▶ Rubberised support surfaces
- ▶ Lateral fixation for firm hold
- ▶ Adjustable in all axes
- ▶ No base support necessary, simply plug in
- ▶ Quick change between laptop and screen holder



07124L 107,90 EUR*

STORAGE COMPARTMENT, MAGNETIC

for magnetic attachment to all metal surfaces e.g. workshop mobile tool chest, workbench etc.. The rubber coating on the 6 powerful magnets prevents coated surfaces becoming scratched. Frequently used tools such as screwdrivers, T-handle wrenches etc. are always on hand thanks to 10 universal round holes à 19.5 mm dia. in the base.

- ▶ Inner dimensions: 210 x 73 x 70 mm
- ▶ 1.8 kg maximum capacity
- ▶ Suitable for 3 spray cans à 70 mm dia.



07006L 15,50 EUR*

GEARBOX LIFTER, 500 KG

for fitting and removing gearboxes, engines, clutches

- ▶ Height approx. 111 - 194 cm
- ▶ 4 casters with ball bearings
- ▶ Casters distance: 60 cm
- ▶ Compact design, low overall weight
- ▶ Extremely large range during lifting
- ▶ Fast lifting thanks to hydraulic foot pump
- ▶ Piston rod: diameter 30 mm



20309L 279,90 EUR*

ENGINE STAND, 570 KG

Can be turned 360° and locked in 8 positions.

- ▶ Casters with ball bearings
- ▶ The 4 mounting points are adjustable in terms of angle and distance
- ▶ The mounting plate can be rotated so that the engine can also be turned



20302L 149,90 EUR*

JACK STAND, 6 T, 1 PAIR

with one-handed operation, four bases.



20475L 91,90 EUR*

JACK STAND, 3 T, 1 PAIR

for one-handed operation, four bases.



20465L 52,50 EUR*

TROLLEY JACK, 2 T

- ▶ Load capacity 2,000 kg
- ▶ Single Lifting height: 135 - 340 mm
- ▶ With casters and safety valve



20700L 58,90 EUR*

HYDRAULIC BOTTLE JACK, 2 T

- ▶ Load capacity: 2,000 kg
- ▶ Lifting height 168 - 316 mm
- ▶ With safety valve



20601L 26,90 EUR*

HYDRAULIC BOTTLE JACK, 20 T

- ▶ Load capacity: 20,000 kg
- ▶ Lifting height 235 - 445 mm
- ▶ With safety valve



20606L 86,90 EUR*

HYDRAULIC BOTTLE JACK, 5 T

- ▶ Load capacity: 5,000 kg
- ▶ Lifting height: 207 - 402 mm
- ▶ With safety valve



20602L 39,90 EUR*

CARBURETTOR SYNCHRONISATION TESTER

For measuring the synchronisation of 2 - 4 carburettors.

- ▶ 4 manometers, mounted on board
- ▶ 4 rubber hoses 8 x 5 x 750 mm
- ▶ 4 hose clamps + replacement sealing rings
- ▶ 4 connectors 53 mm (M6 x 0.75)
- ▶ 4 connectors 60 mm (M6 x 1.00)
- ▶ 4 extensions 3.9 x 52 mm
- ▶ 4 extensions 3.9 x 122 mm



26093L 197,90 EUR*

CHAIN SEPARATION AND RIVETING TOOL

For separating/riveting chain links on roller chains. Also suitable for bicycle/motorcycle chains (o/x ring chains).

- ▶ 2.2 mm - for chains up to ANSI 25 / DIN-ISO 04
- ▶ 2.9 mm - for chains up to ANSI 35 / DIN-ISO 06
- ▶ 3.8 mm - for motorcycle chains in standard sizes 428 - 530



10590L 49,90 EUR*

TROLLEY JACK, 3 T

- ▶ Hydraulic double piston mechanism
- ▶ Quick lifting - effortless
- ▶ Very low in weight but sturdy
- ▶ With rubber pad on bearing area
- ▶ With rod protection on piston rod
- ▶ Lifting height: 130 - 465 mm
- ▶ Carrying load: 3,000 kg



20731L 255,90 EUR*

TROLLEY JACK, 3 T

- ▶ Hydraulic double piston mechanism
- ▶ Quick lifting - effortless
- ▶ Very low in weight but sturdy
- ▶ With rubber pad on bearing area
- ▶ With rod protection on piston rod
- ▶ Lifting height: 100 - 535 mm
- ▶ carrying load: 3000 kg



20741L 329,90 EUR*

WORKSHOP PRESS, 20T

Suitable for heavy-duty day-to-day work in the workshop.

- ▶ Makes the replacement of e.g. wheel bearings, gearshaft bearings, rubber bushes etc. much easier
- ▶ Large working range thanks to 9-fold adjustment of support surface
- ▶ Compression force can be read off on a large dial from 0 to 20 tons
- ▶ Working range: 0 - 910 mm
- ▶ Stroke: 185 mm
- ▶ Working pressure max.: 20 tons



20320L 570,90 EUR*

MAGNETIC STAND

for tyre station, for attachment to lifting platforms and all metallic surfaces. Avoids damage to the impact wrench, torque wrench and compressed air hoses caused by them being dropped on the floor. Conversion times are reduced. The risk of injury caused by compressed air hoses lying about is reduced.



07395L 29,90 EUR*

RADIATOR PRESSURE TESTING TOOL CASE, 25-PIECE

Complete with a pump, thermometer, filling fittings and radiator adapters for almost all passenger cars and light trucks, packed in a plastic case.

- ▶ Measuring range 0 - 2.5 bar
- ▶ Manometer for checking pressure loss
- ▶ Tool for testing locking caps
- ▶ Tool for pressure testing cooling system
- ▶ Includes vacuum servicing set for cleaning the radiator and topping up the coolant



The adapter sizes and information can be found on our website at www.tool-is.com/ www.swstahl.de.

21030L 259,00 EUR*

OIL FILLER, 7,5 L

For filling gears and differentials with oil.

- ▶ 7.5 l oil tank
- ▶ Hose length 160 cm
- ▶ Can be used up to oil viscosity SAE 140
- ▶ Extremely clean due to included return flow valve for targeted recirculation of overfilled oil in the container
- ▶ Per stroke 0,07 l
- ▶ With 8-piece adapter set for the following applications:
- ▶ AT 101 = FORD with thread connection

- ▶ AT 102 = BMW angled
- ▶ AT 103 = VAG short angled
- ▶ AT 104 = VAG long angled
- ▶ AT 105 = VAG short with thread connection
- ▶ AT 106 = Mercedes-Benz with 7 gear automatic transmission M12 x 1,5
- ▶ AT 107 = VAG DSG direct-shift gearbox M24 x 1,5
- ▶ AT 108 = VAG CVT continuously variable automatic M22 x 1,5

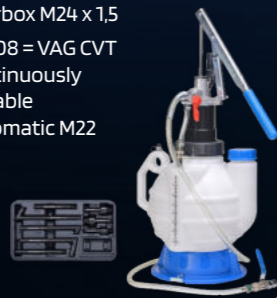

24032L 189,90 EUR*

SPRING TENSIONING SET, 1,800 KG, 5-PIECE

for fast and professional removal and installation of McPherson struts, with safety pin. The set includes the basic tool, two coated disc pairs with polyurethane safety insert and a safety rope.

- ▶ Maximum pressure: 1,800 kg
- ▶ Disc pair for spring diameter up to 120 mm
- ▶ Disc pair for spring diameter up to 200 mm



10207L 499,00 EUR*

REFRACTOMETER

for testing battery acid density from 1.1 - 1.4 kg/l and antifreeze coolant from 0° / -50 °C as well as windscreen washing fluid from 0° / -40°C.

- ▶ Adjustable ocular
- ▶ Settable calibration fixture
- ▶ Measuring accuracy +/- 5%

Used equivalent to VAG OE number T10007 A.



21550L 39,90 EUR*

PNEUMATIC SPRING STRUT COMPRESSOR, MAX. 2,452 KG

Pneumatic high-performance suspension strut tensioner for cars and SUVs.

- ▶ Max. 2,452 kg
- ▶ Dual-position carrier plate for different suspension lengths
- ▶ Protective cage with safety lock
- ▶ Pneumatic cylinder with safety shutoff valves
- ▶ Pedal and safety cover with safety valves
- ▶ Swivel side arms
- ▶ Small and medium-sized supports matching most struts are included in the scope of delivery (for spring diameters 78 - 130 mm and 105 - 182 mm)



10278L 1599,00 EUR*

DIGITAL MULTIMETER, 500 V, CAT II

Compact and handy, high-contrast, one-line LCD display, 19-position rotary switch. The automatic overflow and polarity display provides a reliable warning which helps avoid faults. A temperature sensor allows to measure temperatures between -20°C and +120°C.

- ▶ Set up
- ▶ „Hold“-key
- ▶ Measuring cable with touch protection
- ▶ DC: 0 - 500 V
- ▶ AC: 0 - 500 V
- ▶ DC: 200mA - 10 A
- ▶ Resistance: 0 - 2 MOhm
- ▶ Diode tester
- ▶ Max. display: 1999
- ▶ 9V battery (in the device)



Fuses included:

- ▶ Ceramic fuse: 20 mm, 5 mm diameter, 500 V, 500 mA
- ▶ Ceramic fuse: 20 mm, 5 mm diameter, 500 V, 10 A

32230L 19,95 EUR*

PNEUMATIC SPRING STRUT COMPRESSOR

- ▶ Max. 1226 kg
- ▶ Dual-position carrier plate for different shock absorber lengths
- ▶ Protective cage with safety lock
- ▶ Pneumatic cylinder with safety shut-off valves
- ▶ Pedal and safety cover with safety valves
- ▶ Swivel side arms
- ▶ Small and medium-sized supports matching most struts are included in the scope of delivery (for spring diameters 78 - 130 mm and 125 - 205 mm)



10277L 1199,00 EUR*

COMPRESSION AND PRESSURE LOSS TESTER, 45-PIECE

For the professional testing of compression or pressure loss for most car, HGV, motorcycle, bus, agricultural and marine engines, as well as Hdi, TDCi and pump nozzle engines.

- ▶ Spark plug adapters M10, M12, M14 and M18
- ▶ Compression pressure tester max. 50 bar
- ▶ Straight and angled quick couplings
- ▶ Injection nozzle adapters M20, M22, M24 and for Ford Stanadyne injectors

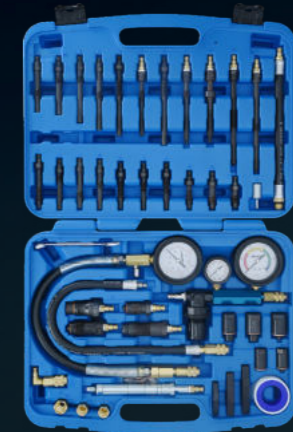

26119L 549,00 EUR*



ERGONOMIC
2-COMPONENT D-HANDLE

CORROSION RESISTANT HANDLE
FROM COATED STEEL



2-COMPONENT-T-HANDLE

CORROSION RESISTANT HANDLE
FROM COATED STEEL

39,90 EUR*

98150L

CONVINCING STRONG

SNOW SHOVEL

For quick and easy snow clearance, e.g. on driveways and walkways

- ▶ Wide plastic blade with robust aluminium profile edge
- ▶ Cold-resistant down to -25 °C



49,90 EUR*

98100L

FOLDING MECHANISM
WITH BRACKET

138 CM TOTAL LENGTH
77.5 CM FOLDED

LOAD CAPACITY MORE THAN 40 KG

LONG LASTING
PLASTIC SHOVEL

50.5 CM WORKING WIDTH

STRONG ALUMINUM
PROFILE EDGE

FOLDING MECHANISM
WITH BRACKET



98 CM TOTAL LENGTH
53.5 CM FOLDED

LOAD CAPACITY OF UP TO 30 KG

LONG LASTING
PLASTIC SHOVEL

25 CM WORKING WIDTH

STRONG SYNTHETIC EDGE

RESCUE SNOW SHOVEL

For flexible use on the move, e.g. around the car, in emergencies or as a helper for everyday tasks

- ▶ Small and space-saving due to folding mechanism
- ▶ Cold-resistant down to -25 °C
- ▶ With storage bag



SNOWPUSH
PREMIUM



SNOWPUSH
RESCUE



TRADITION FUTURE

1957

Hans-Joachim Sauer founded a tool company in Hamburg for the repair of cars and commercial vehicles. He thus laid the foundation for the already then growing tool market for hand and special tools.

As early as the 1970s, Sauer developed time-efficient solutions for complex repairs. Process and material optimisation, time and cost savings have always been important pillars of the SAUER philosophy. Over the years, SAUER distinguished itself as the specialist for automotive repairs.

By the end of the 1990s, the company had built up a very large customer base nationally. But SAUER was also successful internationally, with around 12,000 high-quality products already on the market at that time.

SAUER earlier...

At SAUER, the focus has always been on professional and competent production and competent manufacturing. Even for individual components which are not "Made in Germany", care is taken to ensure that the quality always quality always meets German standards. Thus, the high-quality, visually appealing and, above all, in use visually appealing and, above all, practical in practical product range.



- PKW
- TRANSPORTER
- NFZ
- AGRICULTURE
- INDUSTRY

A STORY OF SUCCESS

THIS IS WHAT WE STAND FOR GERMAN QUALITY STANDARDS

Even today, almost all products are manufactured in Germany. And proven German quality standards are still required and met even for the few components not produced in Germany.

**TECHNISCHE
INNOVATIONEN**
MADE IN GERMANY

SAUER today...

In 2015, the hand and special tool specialist SW-Stahl GmbH took over the SAUER brand rights. Since then, an experienced team of technicians, automotive experts and an accomplished sales and marketing team have been developing a concept to successfully re-establish SAUER in the tool market. To this end, many creative ideas were implemented, improved tool versions were developed and new, problem-solving products were devised. The result is a comprehensive range of intelligent special tools that offers the optimum solution for every possible application. With the focus on quality and functionality, the basic idea of the "old" SAUER is taken up and continued. SAUER products are modular in design, function across all brands and are permanently adapted to the latest technical developments in the automotive market. In this way, investments for the workshop can be reduced.

The SAUER team is the ideal partner when it comes to solving specific repair issues. The experienced technical staff are familiar with the daily problems in the workshop and work continuously on the development and optimisation of intelligent special tools.

SAUER PRESSURE AND SUPPORT SLEEVE SET, 18 – 78 MM, 54-PIECE

Universal pressure and support sleeve set with internal diameters of 18 to 78 mm and lengths of 40 mm, 100 mm, and 120 mm. Ideal for removing and installing rubber bearings and supporting joints.

Content:

- ▶ Pressure and support sleeves, \varnothing 18–78 mm, length 40 mm
- ▶ Pressure and support sleeves, \varnothing 26–70 mm, length 100 mm
- ▶ Pressure/support sleeves \varnothing 72–78 mm, length 120 mm



81230200 1922,60 EUR*

SAUER TOOL KIT FOR DRIVE SHAFTS, 13-PIECE

This tool set is made to insert fixed or glued drive shafts into wheel hubs. The kit includes threaded sleeves for CV joints with external thread from M16 to M30 as well as tension bolts for CV joints with internal thread of M14 and M16.

Content:

- ▶ Support sleeves with bearing, \varnothing 39 mm and \varnothing 46 mm
- ▶ Pulling sleeves M16, M18, M20, M22, M24, M27, M30
- ▶ Pulling bolt for pull sleeves
- ▶ Tension bolt with external thread, M14 and M16
- ▶ Tension nut

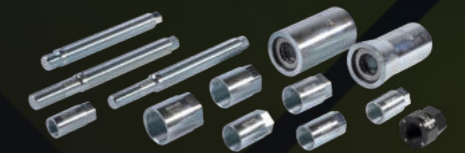

80220600 311,60 EUR*

SAUER RUBBER BEARING TOOL VAG

for the removal and installation of the rubber bearing on the console mule without removing the console (front axle 62 mm diameter)

Suitable for:

- ▶ Audi A2, 00 – ,05
- ▶ Seat Cordoba 6L, 02 – ,09, Ibiza 6L, 02 – ,09
- ▶ Škoda Fabia 6Y, 99 – ,08, Roomster 5J, 06 – ,08
- ▶ VW Fox 5Z, 05 – ,12, Polo 9N, 01 – ,09

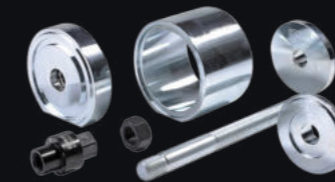

81110400 274,70 EUR*

SAUER TOOL KIT FOR VAG DOUBLE BEARING, 7-PIECE

This tool set is made to remove double bearings in a VAG 5-speed and 6-speed manual gearbox (02T, 02U, 0AF, 0AG, 0AJ, 0DF and 0DQ). The kit contains all tools to remove and install the double bearing and the drive and output shaft in the gearbox. Fits Audi, Seat, Skoda and VW.

Used equivalent to the following OE numbers:

- ▶ Pressure pad for double bearing, T10080
- ▶ Pressure pad for gear shafts, T10081
- ▶ Supporting block for gear shafts, T10083
- ▶ Shim, T10083/1
- ▶ Support plate, T10084A
- ▶ Pressure pad for gear shafts, T10085

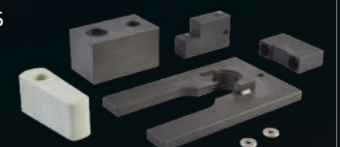

81231900 319,90 EUR*

SAUER PRESSURE PLATE, MODEL 1

for mounting or dismantling of bearings, pinions or CV joints during repair work on wheel bearings, suspension, drive shafts or gearboxes.

Dimensions:

- ▶ 200 x 150 x 14 mm
- ▶ Radii: \varnothing 32, 38, 50, 61

Used equivalent to OEM number VW401.



81231700 109,90 EUR*

SAUER PRESSURE PLATE, MODEL 2

for mounting or dismantling of bearings, pinions or CV joints during repair work on wheel bearings, suspension, drive shafts or gearboxes.

Dimensions:

- ▶ 200 x 150 x 14 mm
- ▶ Radii: \varnothing 31, 50, 56, 83

Used equivalent to OE number VW402.



81231800 109,90 EUR*

SAUER PRESS FRAME, CLOSED DESIGN, 2-PIECE

Sturdy press frame in closed design made of high-strength tempered steel. The enclosed threaded sleeve is designed for pressure pieces with $\varnothing 30$ mm mounts and equipped with the Sauer magnet system. The height can be easily adjusted using the threaded sleeve.

Description:

- ▶ Internal width: 130 mm
- ▶ Internal length: 300 mm
- ▶ Socket thread 1: 2 1/4" - 14 UNS
- ▶ Socket thread 2: M42 x 2.0
- ▶ Max. load: 17 tonnes
- ▶ Weight: 5.5 kg



80220047 306,50 EUR*

SAUER PRESSING CLAMP SET, 7-PIECE

The Sauer pressing clamp is designed for work directly on the vehicle and can be operated both manually and hydraulically.

Description:

- ▶ Internal length: 230 mm
- ▶ Socket thread 1: M42 x 2.0
- ▶ Socket thread 2: M42 x 2.0
- ▶ Max. load: 12 tonnes
- ▶ Weight: 6.6 kg



81230300 381,50 EUR*

SAUER BASIC SET WITH PRESS FRAME, 5-PIECE

With universal press frame in closed design and 20 t hydraulic cylinder. Designed to fit universal pressure and support sleeves with 30 mm connectors.

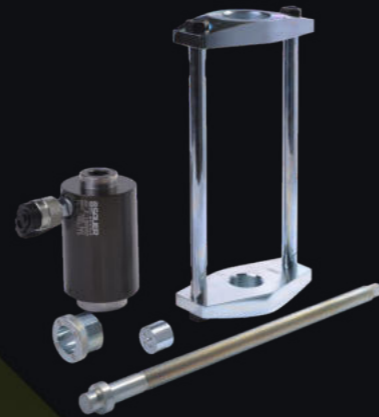

81230500 1250,30 EUR*

SAUER DRIVE SET, HYDRAULIC, 13-PIECE

This basic set is used as a hydraulic drive for almost all tensioning and press work on wheel bearings, drive shafts, rubber bearings and supporting joints. In combination with the Sauer press frames or the Sauer pressure pieces, this set is a must for any workshop.



80220033 1231,00 EUR*

SAUER DRIVE SET, MANUAL

with press frame.



81231601 573,90 EUR*

SAUER FEED SHAFT M10 x 450 MM WITH NUT

For hydraulic pulling



80220004 95,50 EUR*

SAUER FEED SHAFT M14 x 450 MM WITH NUT

For hydraulic pulling

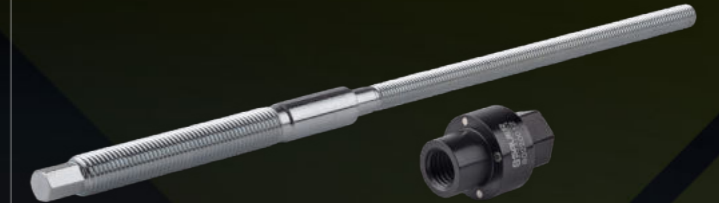

80220010 97,50 EUR*

SAUER FEED SHAFT M12 x 450 MM, WITH NUT

For hydraulic pulling



80220007 96,50 EUR*

SAUER FEED SHAFT M18 x 450 MM WITH NUT

For hydraulic pulling



80220020 106,50 EUR*

SAUER FEED SHAFT M16 x 450 MM WITH NUT

For hydraulic pulling



80220015 89,10 EUR*

SAUER FEED SHAFT M20 x 450 MM WITH NUT

For hydraulic pulling



80220025 106,50 EUR*

**FULL
HONORS
FULL
LOADING**

TT802
B L A C K

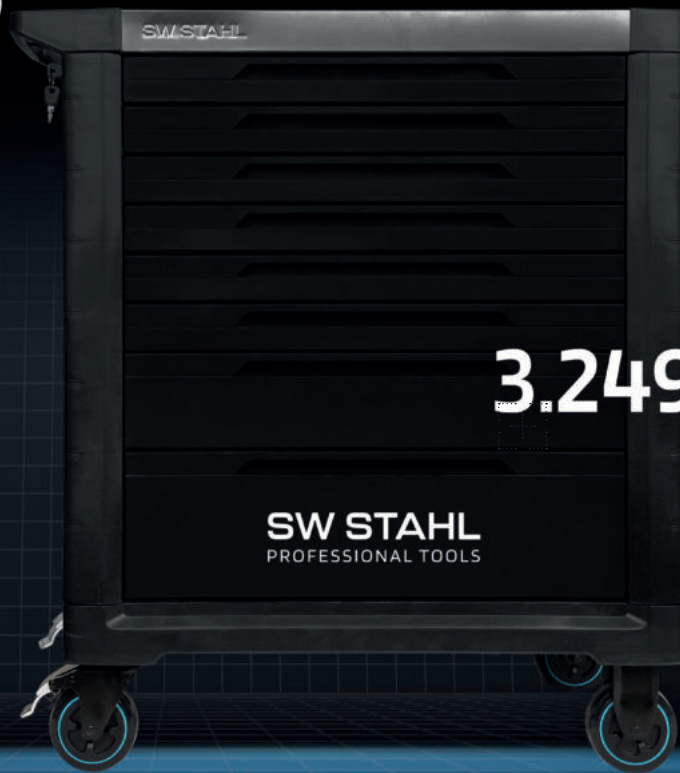

Z3201
3.249,90 €*



SW STAHL
PROFESSIONAL TOOLS

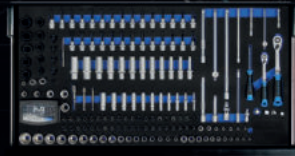

434
PIECES

